

2023



 FERRAL®

FERRAL

1981-2023

PT | Fundada em 1981, a Ferral - José Luís & Ca. Lda. é a empresa Portuguesa líder no fabrico e distribuição de escadas, escadotes e andaimes em alumínio e fibra de vidro. Mais de quatro décadas em constante evolução, a empresa tornou-se uma referência de inovação e competitividade na sua área de atividade, contando hoje com 6 modernas linhas de produção que abrangem uma área coberta de 7.500 m2.

A localização da unidade produtiva, 40 Km a Sul do Porto de Leixões (Porto), foi desde o início da sua atividade uma vantagem competitiva no mercado de exportação, permitindo à Ferral uma diversificação da sua carteira de clientes pelos vários pontos do globo, hoje representada em 40 países e 4 continentes.

Na Ferral trabalhamos interdisciplinarmente para garantir que os produtos que desenvolvemos correspondem às necessidades do mercado, do ponto de vista de função, facilidade de utilização e segurança. A Ferral dispõe de laboratório de testes para acompanhamento do processo de desenvolvimento de produto, garantindo o cumprimento das mais exigentes normas de segurança em vigor. É neste laboratório que são realizados testes diários aos artigos produzidos.

A empresa tem implementado um Sistema de Gestão da Qualidade certificado segundo a norma ISO 9001 para todos os seus processos, assim como um Sistema de Gestão Ambiental com certificação ISO 14001.

Oferecer a todos os clientes uma solução de segurança e confiança no mercado continuará a ser a nossa missão. Somos conscientes da responsabilidade do produto que fabricamos.

EN | Founded in 1981, Ferral - José Luís & Ca. Ltd is the leading Portuguese company in the manufacture and distribution of aluminium and fiberglass ladders, stepladders and scaffolding. Constantly evolving for more than four decades, the company has become a benchmark for innovation and competitiveness in its area of activity, counting today with 6 modern production lines which comprise a covered area of 7.500 m2.

The location of the production unit, 40 km south of the Port of Leixões (Porto), has been a competitive advantage in the export market since the beginning of its activity, allowing Ferral to diversify its customer portfolio across multiple parts of the globe, today represented in 40 countries and 4 continents.

At Ferral, we work interdisciplinary to ensure that the products we develop correspond to the needs of the market, from the point of view of function, ease of use and safety. Ferral has a testing laboratory to monitor the product development process, ensuring compliance with the most demanding safety standards. It is in this laboratory that daily tests are carried out on the articles produced.

The company has implemented a certified Quality Management System, according to the ISO 9001 standard for all its processes, as well as an Environmental Management System with ISO 14001 certification.

To offer all customers a solution that is safe and reliable in the market will continue to be our mission. We are aware of the responsibility of the product we manufacture.

FR | Fondée en 1981, Ferral - José Luís & Ca. Ltd est la principale entreprise portugaise dans la fabrication et la distribution d'échelles, d'escabeaux et d'échafaudages en aluminium et fibre de verre. En quatre décennies en constante évolution, l'entreprise est devenue une référence en matière d'innovation et de compétitivité dans son domaine d'activité, comptant aujourd'hui 6 lignes de production modernes couvrant une surface couverte de 7.500 m2.

L'emplacement de l'unité de production, au sud du port de Leixões (Porto), reste un avantage concurrentiel sur le marché de l'exportation, permettant à Ferral de diversifier son portefeuille de clients dans les différentes parties du globe, aujourd'hui représenté dans 40 pays et 4 continents.

Chez Ferral, nous travaillons de manière interdisciplinaire pour nous assurer que les produits que nous développons correspondent bien aux besoins du marché, du point de vue de la fonction, de la facilité d'utilisation et de la sécurité. Ferral dispose d'un laboratoire d'essais pour surveiller le processus de développement des produits, garantissant le respect des normes de sécurité les plus exigeantes en vigueur. C'est dans ce laboratoire que des tests quotidiens sont effectués sur les produits.

L'entreprise a mis en place un Système de Management de la Qualité certifié selon la norme ISO 9001 pour l'ensemble de ses processus, ainsi qu'un Système de Management Environnemental certifié ISO 14001.

Offrir à tous les clients une solution sûre et fiable sur le marché continuera d'être notre mission. Nous sommes conscients de la responsabilité du produit que nous fabriquons.

ES | Fundada en 1981, Ferral - José Luís & Ca. Lda. es la empresa portuguesa líder en fabricación y distribución de escaleras, andamios de aluminio y fibra de vidrio. En constante evolución durante cuatro décadas, la empresa ha logrado convertirse en un claro referente en innovación y competitividad dentro de su área de actividad, con una superficie cubierta superior a los 7.500 m2 que alberga 6 modernas líneas de producción.

La ubicación de la unidad productiva, 40 km al sur del Puerto de Leixões (Oporto), ha supuesto una gran ventaja competitiva para el mercado de exportación, desde el inicio de su actividad, permitiendo a Ferral diversificar su cartera de clientes en las distintas partes del globo, abarcando hoy más de 40 países y 4 de los 5 continentes.

En Ferral trabajamos de forma interdisciplinar para que los productos que desarrollamos logren satisfacer las necesidades de nuestros clientes, desde el punto de vista funcional, facilidad de uso y la seguridad. Ferral dispone de un laboratorio de ensayos para garantizar el proceso de desarrollo de producto, asegurando el cumplimiento de las más exigentes normas de seguridad vigentes. Es en este laboratorio, se realizan pruebas diarias a los artículos producidos.

La empresa tiene implantado un Sistema de Gestión de Calidad certificado según la norma ISO 9001 para todos sus procesos, así como un Sistema de Gestión Medioambiental con certificación ISO 14001.

Nuestra misión, es "Ofrecer a todos nuestros clientes una solución segura y fiable en altura" con el máximo compromiso y responsabilidad en el diseño y fabricación de nuestros productos.







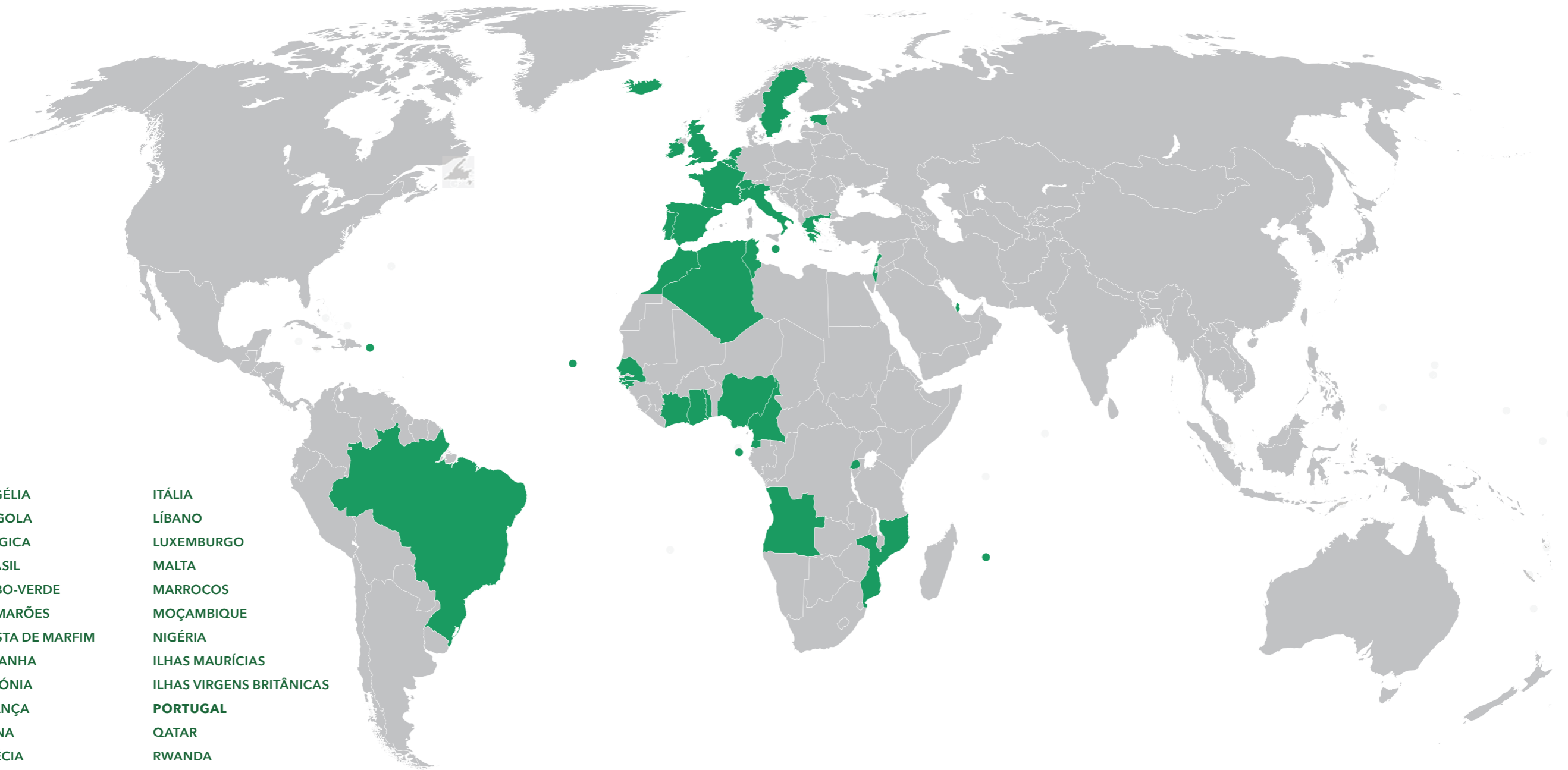

- ARGÉLIA
- ANGOLA
- BÉLGICA
- BRASIL
- CABO-VERDE
- CAMARÕES
- COSTA DE MARFIM
- ESPAÑA
- ESTÓNIA
- FRANÇA
- GANA
- GRÉCIA
- GUINÉ BISSAU
- HOLANDA
- INGLATERRA
- IRLANDA
- ISLÂNDIA
- ISRAEL
- ITÁLIA
- LÍBANO
- LUXEMBURGO
- MALTA
- MARROCOS
- MOÇAMBIQUE
- NIGÉRIA
- ILHAS MAURÍCIAS
- ILHAS VIRGENS BRITÂNICAS
- PORTUGAL**
- QATAR
- RWANDA
- S. TOMÉ E PRÍNCIPE
- SENEGAL
- SUÉCIA
- SUÍÇA
- TOGO
- TÚNISIA

ÍNDICE

INDEX | INDICE | ÍNDICE

PRO SERIES **14**

ENERGY **36**

VOLT **54**



PRO SERIES

Equipamento para os mais profissionais.
Equipment for hardworking people.
Équipement pour les plus professionnels.
Equipo para los más profesionales.

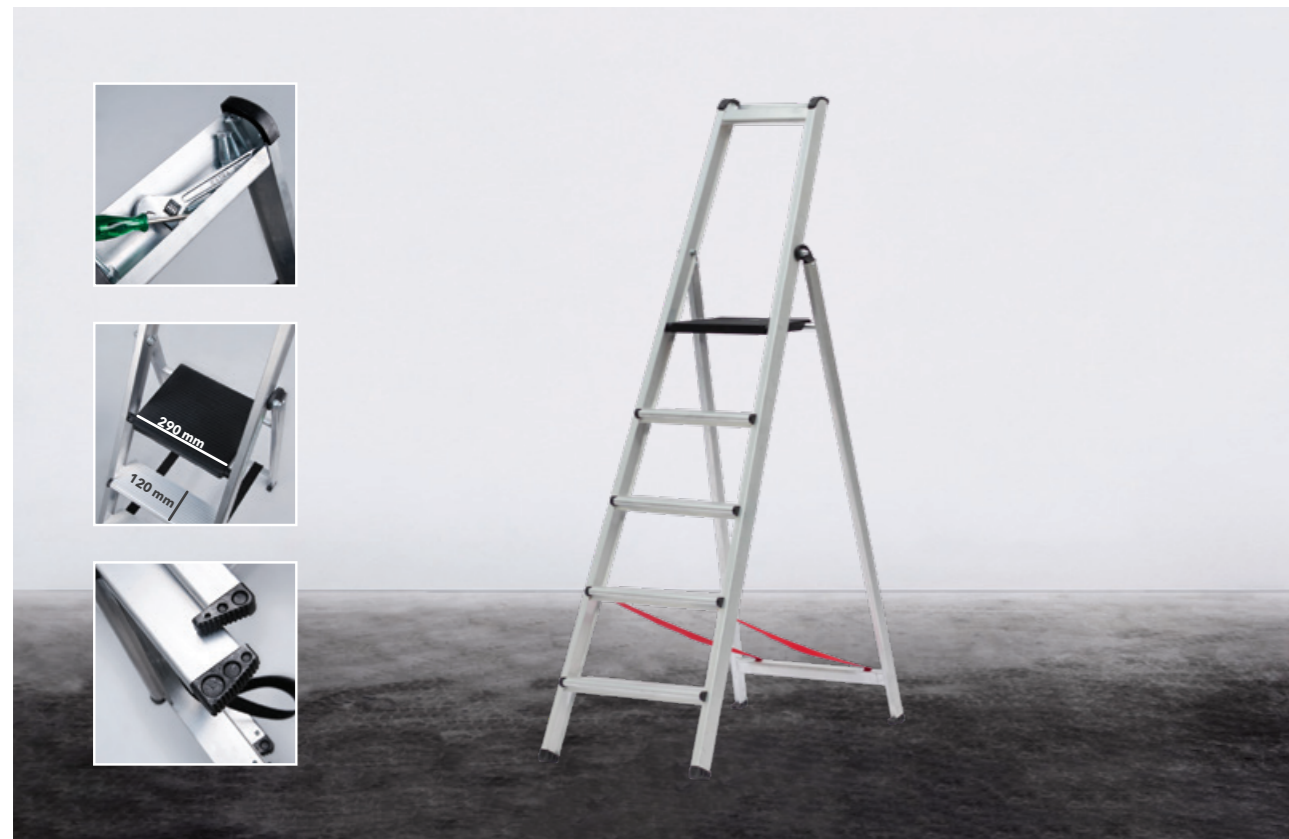

	Icon 1	Icon 2	Icon 3	Icon 4	Icon 5	Icon 6	Icon 7	Icon 8	Icon 9
5604620023132	3	0,66m	2,66m	1,29m	0,49m	1,40m	0,12m	5,60kg	
5604620023149	4	0,88m	2,88m	1,52m	0,51m	1,66m	0,12m	6,73kg	
5604620023156	5	1,10m	3,10m	1,71m	0,53m	1,88m	0,12m	7,88kg	
5604620023163	6	1,33m	3,33m	1,95m	0,56m	2,11m	0,12m	9,34kg	
5604620023170	7	1,57m	3,57m	2,17m	0,58m	2,37m	0,12m	10,57kg	
5604620023187	8	1,80m	3,80m	2,40m	0,61m	2,61m	0,12m	11,85kg	
5604620023194	9	2,01m	4,01m	2,64m	0,63m	2,89m	0,12m	13,15kg	

EXTRA

Escadote profissional em alumínio - Soldadura Robotizada. Degraus antiderrapantes (120 mm) e plataforma (290 mm) com largura Extra, articulações de alta qualidade e porta ferramentas. Cintas de segurança e pés antiderrapantes Extra.

Professional aluminium stepladder - Robotic Welding. Extra deep tread non-slip steps (120 mm) and platform (290 mm), high quality hinges and tool holder. Safety straps and Extra slip-resistant feet.

Escabeau professionnel en aluminium - Soudage Robotique. Marches antidérapantes (120 mm) et plateforme (290 mm) Extra-larges, charnières de haute qualité et porte-outils. Sangles de sécurité et sabot emboitable antidérapant Extra.

Escalera profesional de aluminio - Soldadura Robótica. Peldaños antideslizantes (120 mm) y plataforma (290 mm) Extra anchos, bisagras de alta calidad y bandeja porta-herramientas. Cintas de seguridad y tacos antideslizantes Extra.

OPÇÃO
OPTION | OPTION | OPCION



EXTRA LIGHT - SOB CONSULTA | UPON REQUEST | SUR DEMAND | BAJO CONSULTA.

EN 131

PRO

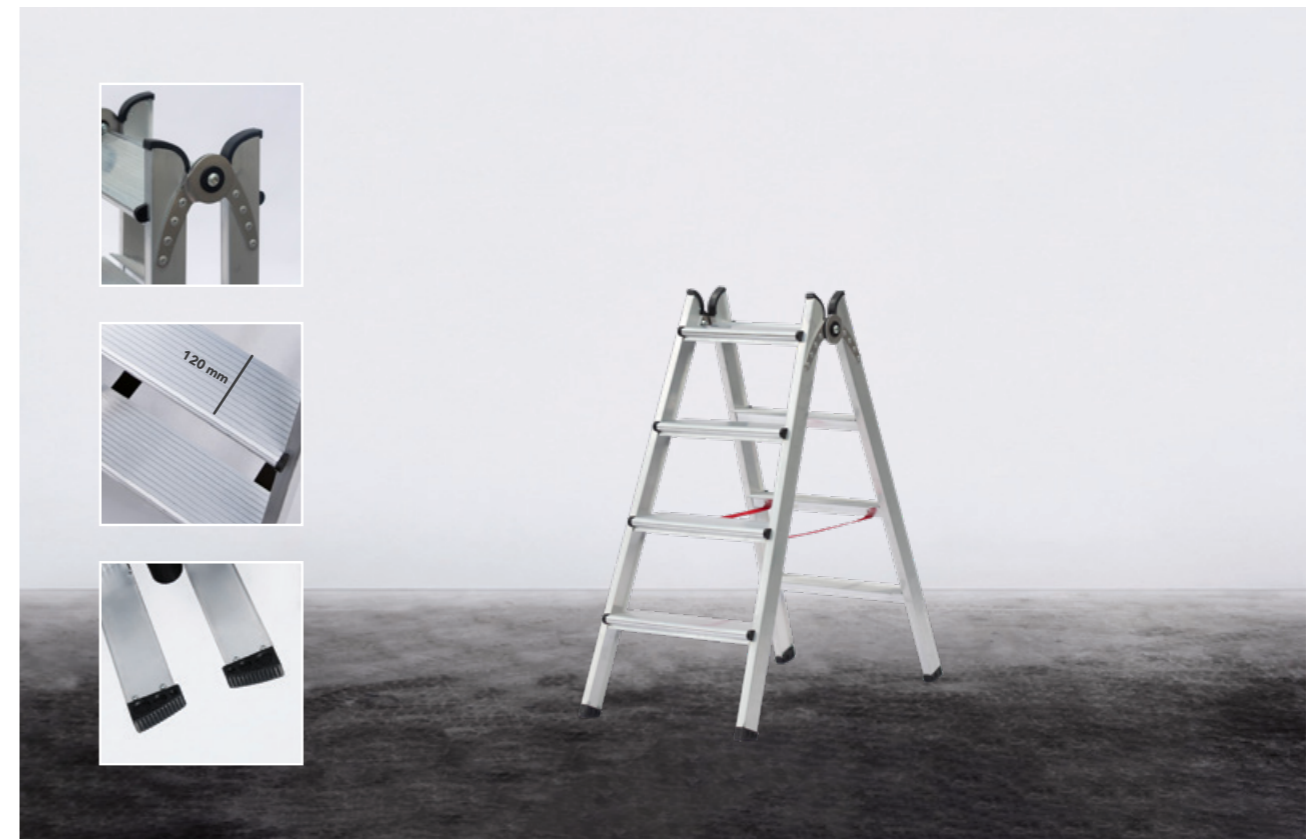

	Icon 1	Icon 2	Icon 3	Icon 4	Icon 5	Icon 6	Icon 7	Icon 8	Icon 9
5604620023330	3	0,13m	2,13m	0,70m	0,46m	0,74m	0,23m	6,19kg	
5604620023347	4	0,38m	2,38m	0,94m	0,48m	0,99m	0,23m	8,00kg	
5604620023354	5	0,61m	2,61m	1,17m	0,50m	1,24m	0,23m	9,87kg	
5604620023361	6	0,85m	2,85m	1,41m	0,53m	1,49m	0,23m	11,80kg	
5604620023378	7	1,08m	3,08m	1,64m	0,56m	1,74m	0,23m	13,80kg	
5604620023385	8	1,31m	3,31m	1,87m	0,59m	1,99m	0,23m	15,86kg	

DUO

Escadote profissional de duplo acesso em alumínio - Soldadura Robotizada. Degraus antiderrapantes (120 mm) e articulações de segurança. Cintas de segurança e pés antiderrapantes Extra.

Professional aluminium double-sided stepladder - Robotic Welding. Extra deep tread non-slip steps (120 mm) and safety hinges. Safety straps and Extra slip-resistant feet.

Escabeau professionnel double accès en aluminium - Soudage Robotique. Marches antidérapantes Extra-larges (120 mm) et charnières de sécurité. Sangles de sécurité et sabot emboitable antidérapant Extra.

Escalera profesional de aluminio de doble acceso - Soldadura Robótica. Peldaños antideslizantes Extra anchos (120 mm) y bisagras de alta seguridad. Cintas de seguridad y tacos antideslizantes Extra.

OPÇÃO
OPTION | OPTION | OPCION



DUO LIGHT - SOB CONSULTA | UPON REQUEST | SUR DEMAND | BAJO CONSULTA.

EN 131

PRO



5604620013201	4x3	0,96m	3,52m	3,40m	4,59m	1,77m	1,71m	2,90m	1,00m	3,00m	0,35m	0,27m	15,96kg

MULTIFLEX

Escada multifunções profissional em alumínio com plataforma. Utilizável em 3 posições diferentes: escada extensível, posição de escadote e bancada de trabalho (1400x300 mm). Degrau antiderrapante confortável (30x30 mm) e largura interior da escada com 300 mm. Articulações Multiflex e estabilizador antiderrapante.

Aluminium professional multi-purpose ladder with platform. Ladder can be used in 3 different positions: extension ladder position, standing position and work platform (1400x300 mm). Comfortable non-slip rung (30x30 mm) and inner width of the ladder 300 mm. Multiflex hinges and slip-resistant cross-beam.

Échelle multi positions professionnelle en aluminium avec plateforme. Utilisable en 3 positions différentes: échelle simple, autostable et plateforme de travail (1400x300 mm). Échelons antidérapant confortable (30x30 mm) et largeur intérieure de l'échelle de 300 mm. Articulation Multiflex et embase stabilisatrice antidérapant.

Escalera multifuncional profesional de aluminio con plataforma. La escalera se puede cambiar en 3 posiciones: extensible, tijera y plataforma de trabajo (1400x300 mm). Cómodo peldaño antideslizante (30x30 mm) y ancho interior de la escalera de 300 mm. Bisagras Multiflex y patas antideslizantes.

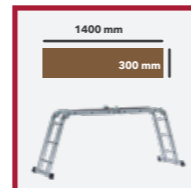

EN 131

PRO

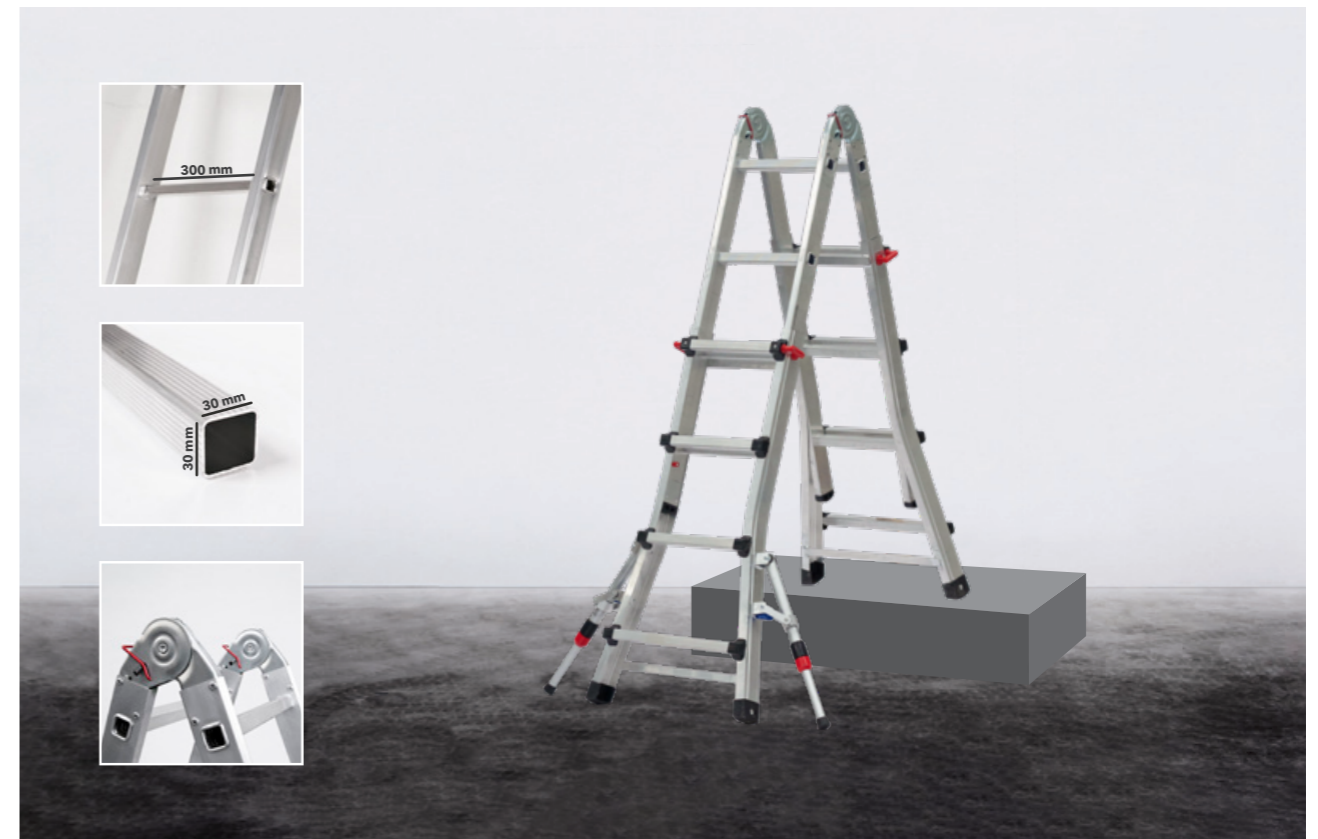

5604620001345	3+3	0,94m	2,91m	2,81m	4,00m	1,49m	1,44m	2,63m	0,56m	0,22m	10,51kg	
5604620001352	3+4	1,22m	3,47m	3,35m	4,54m	1,77m	1,71m	2,90m	0,56m	0,22m	11,46kg	
5604620001369	4+4	1,22m	4,03m	3,89m	5,08m	2,05m	1,98m	3,17m	0,56m	0,22m	12,61kg	
5604620001376	4+5	1,50m	4,59m	4,43m	5,62m	2,33m	2,25m	3,44m	0,56m	0,22m	13,55kg	
5604620001413	5+5	1,50m	5,15m	4,97m	6,16m	2,61m	2,52m	3,71m	0,56m	0,22m	17,69kg	
5604620001437	5+6	1,78m	5,71m	5,51m	6,70m	2,89m	2,79m	3,98m	0,56m	0,22m	18,83kg	
5604620001420	6+6	1,78m	6,27m	6,06m	7,24m	3,17m	3,06m	4,25m	0,56m	0,22m	20,36kg	

TELEFLEX

Escada articulada telescópica profissional em alumínio. Utilizável em 3 posições diferentes: escada extensível, posição de escadote e em superfícies desniveladas. Degrau antiderrapante confortável (30x30 mm) e largura interior da escada com 300 mm. Articulações Multiflex, sistema de bloqueio da parte deslizante e tacos antiderrapantes. Estabilizador Jumbo para máxima estabilidade e preparado para superfícies irregulares.

Aluminium professional multi-purpose telescopic ladder. Ladder can be used in 3 different positions: extension ladder position, standing position and working on uneven ground. Comfortable non-slip rung (30x30 mm) and inner width of the ladder 300 mm. Multiflex hinges, sliding mechanism with locks and slip-resistant feet. Jumbo stabilizer for maximum stability and prepared for uneven surfaces.

Échelle pliante télescopique professionnelle en aluminium. Utilisable en 3 positions différentes: échelle simple, autostable et en dénivelés. Échelons antidérapant confortable de (30x30 mm) et largeur intérieure de l'échelle de 300 mm. Articulation multiflex, système de blocage du plan coulissant et sabots antidérapants. Stabilisateur Jumbo pour une stabilité optimale et préparé pour les surfaces inégales.

Escalera telescópica multifunción profesional de aluminio. La escalera se puede cambiar en 3 posiciones diferentes: extensible, tijera y para trabajo en desnivel. Cómodo peldaño antideslizante de (30x30 mm) y ancho interior de la escalera de 300 mm. Bisagras Multiflex, sistema de posicionamiento con agarre y patas antideslizantes. Estabilizador Jumbo para máxima estabilidad y preparado para superficies irregulares.



EN 131

PRO



	Icon 1	Icon 2	Icon 3	Icon 4	Icon 5	Icon 6	Icon 7	Icon 8	Icon 9
5604620060021	2	0,48m	2,48m	1,59m	0,64m	1,99m	0,38m	17,66kg	
5604620060038	3	0,72m	2,72m	1,82m	0,65m	2,19m	0,38m	19,94kg	
5604620060045	4	0,95m	2,95m	2,05m	0,65m	2,49m	0,38m	21,24kg	
5604620060052	5	1,20m	3,20m	2,30m	0,65m	2,76m	0,38m	22,81kg	
5604620060069	6	1,43m	3,43m	2,53m	0,65m	3,04m	0,38m	24,67kg	
5604620060076	7	1,66m	3,66m	2,76m	0,65m	3,28m	0,38m	25,97kg	
5604620060083	8	1,95m	3,95m	3,05m	0,65m	3,54m	0,38m	27,09kg	

PROTECT

Plataforma profissional de trabalho portátil em alumínio com guarda-corpos de segurança. Proteção traseira, portas de acesso automáticas e porta ferramentas. Degraus (60 mm) e plataforma alargados (455x600 mm) para reforçar o conforto e a resistência do produto. Facilidade de transporte e arrumação.

Aluminium professional mobile working platform with safety guardrails. Fall protection safety gates with automatic mechanism and toolholder. Large steps (60 mm) and platform (455x600 mm) to improve comfort and increase performance of the product. Easy transport and storage.

Plateforme Individuelle Roulante Légère (PIRL) professionnelle en aluminium avec garde-corps. Portillon à fermeture automatique, porte-outils y tablette porte bidon. Construction robuste avec marches (60 mm) et plateforme (455x600 mm) de grande dimension pour améliorer le confort. Facile à transporter et à stocker.

Plataforma de móvil profesional de aluminio con barandillas de seguridad. Protección trasera, puerta automática y bandeja porta-herramientas. Peldaños (60 mm) y plataforma (455x600 mm) anchos para máxima comodidad y reforzar al máximo la resistencia del producto. Fácil almacenamiento y transporte.

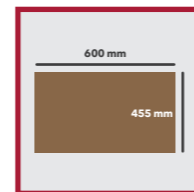

PROTECT LIGHT - SOB CONSULTA | UPON REQUEST | SUR DEMAND | BAJO CONSULTA.

EN 131

PRO



	Icon 1	Icon 2	Icon 3	Icon 4	Icon 5	Icon 6	Icon 7	Icon 8	Icon 9
5604620060137	3-4	Min 0,71m Max 0,89m	Min 2,71m Max 2,89m	Min 1,81m Max 1,99m	0,65m	2,23m	0,49m	24,69kg	
5604620060144	4-6	Min 0,94m Max 1,37m	Min 2,94m Max 3,37m	Min 2,04m Max 2,47m	0,66m	2,49m	0,49m	28,73kg	
5604620060151	5-8	Min 1,19m Max 1,89m	Min 3,19m Max 3,89m	Min 2,29m Max 2,99m	0,66m	2,76m	0,49m	32,09kg	

PROTECT FLEX

Plataforma telescópica profissional de trabalho portátil em alumínio com guarda-corpos de segurança. Proteção traseira, portas de acesso automáticas e porta ferramentas. Degraus (60 mm) e plataforma alargados (455x600 mm) para reforçar o conforto e a resistência do produto. Altura de trabalho ajustável (ideal para utilização em superfícies desniveladas), facilidade de transporte e arrumação.

Aluminium professional telescopic mobile working platform with safety guardrails. Fall protection safety gates with automatic mechanism and toolholder. Large steps (60 mm) and platform (455x600 mm) to improve comfort and increase performance of the product. Simple height adjustment (adjustable on uneven surfaces), easy transport and storage.

Plateforme Individuelle Roulante Légère (PIRL) télescopique professionnelle en aluminium avec garde-corps. Portillon à fermeture automatique, porte-outils y tablette porte bidon. Construction robuste avec marches (60 mm) et plateforme (455x600 mm) de grande dimension pour améliorer le confort. Utilisable dans les escaliers, facile à transporter et à stocker.

Plataforma telescópica de trabajo móvil profesional de aluminio con barandillas de seguridad. Protección trasera, puerta automática y bandeja porta-herramientas. Peldaños (60 mm) y plataforma (455x600 mm) anchos para máxima comodidad y reforzar al máximo la resistencia del producto. Altura de trabajo regulable (Ideal para trabajos en desnivel), fácil almacenamiento y transporte.

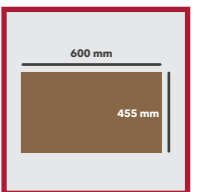

PROTECT FLEX LIGHT - SOB CONSULTA | UPON REQUEST | SUR DEMAND | BAJO CONSULTA.

EN 131

PRO



	Icon 1	Icon 2	Icon 3	Icon 4	Icon 5	Icon 6	Icon 7	Icon 8	Icon 9
5604620015120	2	0,44m	2,44m	0,81m	0,45m	0,78m	0,12m	6,90kg	
5604620015137	3	0,66m	2,66m	1,28m	0,47m	1,09m	0,12m	9,60kg	
5604620015144	4	0,88m	2,88m	1,49m	0,50m	1,40m	0,12m	12,60kg	

JOKER

Escadote profissional em alumínio extra-largo com arco de segurança. Plataformas alargadas (230x360 mm) antiderrapantes e porta ferramentas. Facilidade de transporte e arrumação.

Extra-large folding stepladder with safety rail. Large non-slip rubber steps (230x360 mm) and toolholder. Easy to transport and storage.

Marchepied extra-large avec garde corps. Marches de grande dimension (230x360 mm) avec tapis antidérapants y porte-outils. Facile à transporter et à stocker.

Escalera extra-ancha con arco de seguridad. Peldaños anchos antideslizantes (230x360 mm) y bandeja porta-herramientas. Fácil almacenamiento y transporte.



EN 131

PRO



	Icon 1	Icon 2	Icon 3	Icon 4	Icon 5	Icon 6	Icon 7	Icon 8	Icon 9
5604620150050	5	1,10m	3,10m	2,00m	0,58m	3,13m	0,24m	27,13kg	
5604620150067	6	1,30m	3,30m	2,20m	0,58m	3,37m	0,24m	30,11kg	
5604620150074	7	1,50m	3,50m	2,40m	0,62m	3,62m	0,24m	34,44kg	
5604620150081	8	1,70m	3,70m	2,60m	0,62m	3,86m	0,24m	35,75kg	
5604620150098	9	1,90m	3,90m	2,80m	0,62m	4,11m	0,24m	38,71kg	
5604620150104	10	2,10m	4,10m	3,00m	0,62m	4,35m	0,24m	40,59kg	
5604620150111	11	2,30m	4,30m	3,20m	0,62m	4,60m	0,24m	42,19kg	
5604620150128	12	2,50m	4,50m	3,40m	0,62m	4,84m	0,24m	44,88kg	

PODIUM

Plataforma de trabalho móvel em alumínio. Rodas giratórias, degraus (120 mm) e plataforma alargados (455x600 mm) para reforçar o conforto e a resistência do produto, porta ferramentas e corrimão de segurança. Facilidade de montagem e transporte. Ideal para utilização em armazéns.

Mobile aluminium warehouse platform. Castors wheels, large steps (120 mm) and platform (455x600 mm) to improve comfort and increase performance of the product, tool holder and safety handrails. Easy assembly and transport. Ideal for use in warehouses.

Plateforme individuelle roulante en aluminium. Roues pivotantes, construction robuste avec marches (120 mm) et plateforme (455x600 mm) de grande dimension pour améliorer le confort, porte-outils et rampes de sécurité. Montage et transport facile. Idéale pour une utilisation dans les entrepôts.

Plataforma de trabajo de aluminio móvil. Ruedas giratorias, peldaños (120 mm) y plataforma (455x600 mm) anchos para máxima comodidad y reforzar al máximo la resistencia del producto, porta herramientas y pasamanos de seguridad. Facilidad de montaje y transporte. Ideal para uso en almacenes.

PODIUM LIGHT - SOB CONSULTA | UPON REQUEST | SUR DEMAND | BAJO CONSULTA.

EN 131

PRO

OPÇÃO
OPTION | OPTION | OPCIÓN



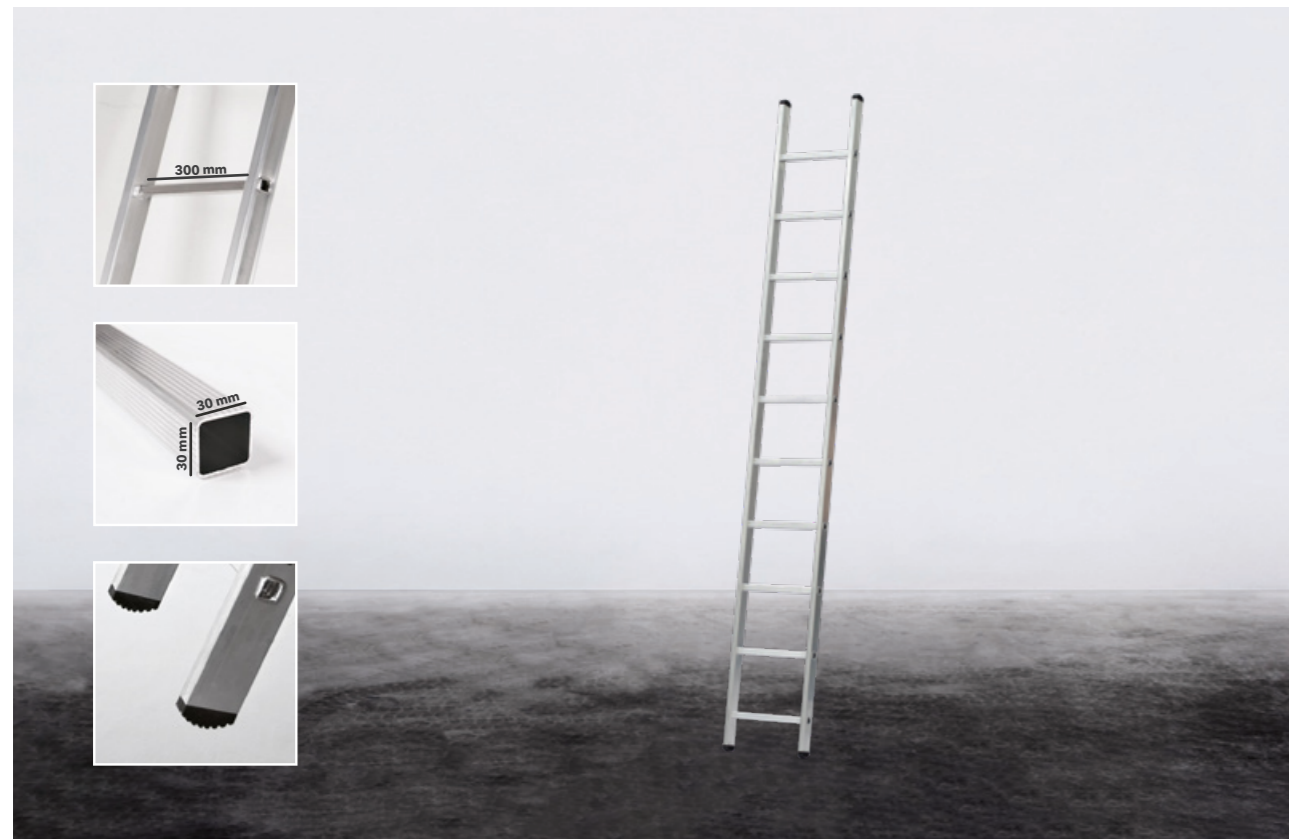

Model	Steps	Max Height	Working Height	Extension Length	Inner Width	Foot Width	Weight
5604620130069	6	1,76m	1,70m	2,89m	0,35m	60mm	2,87kg
5604620130076	7	2,04m	1,97m	3,16m	0,35m	60mm	3,32kg
5604620130083	8	2,32m	2,25m	3,43m	0,35m	60mm	3,77kg
5604620130090	9	2,60m	2,52m	3,70m	0,35m	60mm	4,22kg
5604620130106	10	2,88m	2,79m	3,97m	0,35m	60mm	4,67kg
5604620130120	12	3,44m	3,33m	4,52m	0,35m	60mm	6,21kg
5604620130144	14	4,00m	3,87m	5,06m	0,35m	66mm	7,55kg
5604620130168	16	4,56m	4,41m	5,60m	0,35m	66mm	8,49kg
5604620130182	18	5,12m	4,95m	6,14m	0,35m	73mm	10,07kg
5604620130205	20	5,68m	5,49m	6,68m	0,35m	73mm	12,28kg

ELITE X1

Escada profissional simples, de 1 lance, em alumínio. Degrau antiderrapante confortável (30x30 mm) e largura interior da escada com 300 mm. Tacos antiderrapantes e estabilizador de segurança (antiderrapante) a partir de 12 degraus.

Aluminium professional single section rung ladder. Comfortable non-slip rung (30x30 mm) and inner width of the ladder 300 mm. Slip-resistant feet and safety cross-beam (slip-resistant) from 12 rungs.

Échelle professionnelle simple 1 plan en aluminium. Échelons antidérapant confortable (30x30 mm) et largeur intérieure de l'échelle de 300 mm. Sabots antidérapants et embase stabilisatrice (antidérapant) pour plus de sécurité dès 12 échelons.

Escalera industrial profesional de aluminio simple de 1 tramo. Cómodo peldaño antideslizante (30x30 mm) y ancho interior de la escalera de 300 mm. Patas antideslizantes y base estabilizadora (antideslizante) de seguridad a partir de 12 peldaños.



EN 131

PRO



Model	Steps	Max Height	Working Height	Extension Length	Inner Width	Foot Width	Weight				
5604620230066	2x6	1,76m	2,88m	2,79m	3,97m	1,76m	1,70m	2,89m	0,41m	0,12m	7,51kg
5604620230073	2x7	2,04m	3,44m	3,33m	4,52m	2,04m	1,97m	3,16m	0,41m	0,12m	8,43kg
5604620230080	2x8	2,32m	4,00m	3,87m	5,06m	2,32m	2,25m	3,43m	0,41m	0,12m	9,41kg
5604620230097	2x9	2,60m	4,28m	4,14m	5,33m	2,60m	2,52m	3,70m	0,41m	0,12m	10,34kg
5604620230103	2x10	2,88m	4,84m	4,68m	5,87m	2,88m	2,79m	3,97m	0,41m	0,13m	11,94kg
5604620230127	2x12	3,44m	5,96m	5,76m	6,95m	3,44m	3,33m	4,52m	0,41m	0,14m	15,50kg
5604620230141	2x14	4,00m	6,80m	6,57m	7,76m	4,00m	3,87m	5,06m	0,41m	0,14m	18,54kg

ELITE X2

Escada profissional transformável de 2 lances em alumínio. Gancho profissional e de fácil utilização para transformar a escada em posição de escadote. Degrau antiderrapante confortável (30x30 mm) e largura interior da escada com 300 mm. Estabilizador antiderrapante e cintas de segurança.

Aluminium professional 2 section combination ladder. Professional and easy-to-use hook to transform the ladder in standing position. Comfortable non-slip rung (30x30 mm) and inner width of the ladder 300 mm. Slip-resistant cross-beam and safety straps.

Échelle professionnelle transformable 2 plans en aluminium. Articulation professionnel et facile à utiliser pour transformer l'échelle en position autostable. Échelons antidérapant confortable (30 x 30 mm) et largeur intérieure de l'échelle de 300 mm. Embase stabilisatrice antidérapant et sangles de sécurité.

Escalera industrial profesional de aluminio de 2 tramos. Gancho profesional y fácil de utilizar para transformar la escalera en posición de tijera. Cómodo peldaño antideslizante (30 x 30 mm) y ancho interior de la escalera de 300 mm. Base estabilizadora antideslizante y cintas de seguridad.

ELITE X2 LIGHT - SOB CONSULTA | UPON REQUEST | SUR DEMAND | BAJO CONSULTA.

EN 131

PRO

OPÇÃO
OPTION | OPTION | OPCIÓN





	Icon 1	Icon 2	Icon 3	Icon 4	Icon 5	Icon 6	Icon 7	Icon 8	Icon 9	Icon 10	Icon 11	Icon 12
5604620330063	3x6	1,76m	4,00m	3,87m	5,06m	2,88m	2,78m	3,97m	0,48m	0,16m	11,38kg	
5604620330070	3x7	2,04m	4,56m	4,41m	5,60m	3,16m	3,06m	4,25m	0,48m	0,18m	13,19kg	
5604620330087	3x8	2,32m	5,12m	4,95m	6,14m	3,72m	3,60m	4,79m	0,48m	0,18m	14,96kg	
5604620330094	3x9	2,60m	6,52m	6,30m	7,49m	4,28m	4,14m	5,33m	0,48m	0,19m	17,12kg	
5604620330100	3x10	2,88m	6,80m	6,57m	7,76m	4,84m	4,68m	5,87m	0,48m	0,19m	19,31kg	
5604620330124	3x12	3,44m	7,64m	7,38m	8,57m	5,68m	5,49m	6,68m	0,48m	0,20m	23,32kg	

ELITE X3

Escada profissional transformável de 3 lances em alumínio. Degrau antiderrapante confortável (30x30 mm) e largura interior da escada com 300 mm. Gancho profissional e de fácil utilização para transformar a escada em posição de escadote. Estabilizador antiderrapante e cintas de segurança.

Aluminium professional 3 section combination ladder. Professional and easy-to-use hook to transform the ladder in standing position. Comfortable non-slip rung (30x30 mm) and inner width of the ladder 300 mm. Slip-resistant cross-beam and safety straps.

Échelle professionnelle transformable 3 plans en aluminium. Articulation professionnel et facile à utiliser pour transformer l'échelle en position autostable. Échelons antidérapant confortable de (30x30 mm) et largeur intérieure de l'échelle de 300 mm. Embase stabilisatrice antidérapant et sangles de sécurité.

Escalera industrial profesional transformable de aluminio de 3 tramos. Gancho profesional y fácil de utilizar para transformar la escalera en posición de tijera. Cómodo peldaño antideslizante de 30 x 30 mm y ancho interior de la escalera de 300 mm. Base estabilizadora antideslizante y cintas de seguridad.

ELITE X3 LIGHT - SOB CONSULTA | UPON REQUEST | SUR DEMAND | BAJO CONSULTA.

EN 131

PRO

OPÇÃO
OPTION | OPTION | OPCIÓN



	Icon 1	Icon 2	Icon 3	Icon 4	Icon 5	Icon 6	Icon 7	Icon 8	Icon 9	Icon 10	Icon 11	Icon 12
5604620400100	2x10	2,88m	4,84m	4,68m	5,87m	0,41m	0,13m	14,91kg				
5604620400124	2x12	3,44m	5,96m	5,76m	6,95m	0,41m	0,13m	17,39kg				
5604620400148	2x14	4,00m	6,80m	6,57m	7,76m	0,41m	0,13m	19,88kg				
5604620400162	2x16	4,56m	7,64m	7,38m	8,57m	0,41m	0,14m	23,49kg				
5604620400186	2x18	5,12m	8,76m	8,46m	9,65m	0,41m	0,16m	27,64kg				
5604620400209	2x20	5,68m	9,60m	9,28m	10,47m	0,41m	0,16m	30,45kg				

CORDA X2

Escada profissional de 2 lances extensível com corda em alumínio. Mecanismo de corda e rodas para facilitar a abertura da escada sem articulações laterais, prevenindo lesões na utilização do produto. Degrau antiderrapante confortável (30x30 mm) e largura interior da escada com 300 mm.

Aluminium professional 2 section extension ladder - rope operated. Rope mechanism and wheels to facilitate the opening of the ladder without side hinges, preventing injuries when using the product. Comfortable non-slip rung (30x30 mm) and inner width of the ladder 300 mm.

Échelle professionnelle coulissante à corde 2 plans en aluminium. Mécanisme à corde et roues pour faciliter l'ouverture de l'échelle sans articulations latérales, évitant les blessures lors de l'utilisation du produit. Échelons antidérapant confortable de (30x30 mm) et largeur intérieure de l'échelle de 300 mm.

Escalera profesional extensible 2 tramos con cuerda de aluminio. Mecanismo de cuerda y ruedas para facilitar la apertura de la escalera sin bisagras laterales, evitando lesiones al utilizar el producto. Cómodo peldaño antideslizante de (30x30 mm) y ancho interior de la escalera de 300 mm.



> 4,00 m

EN 131

PRO

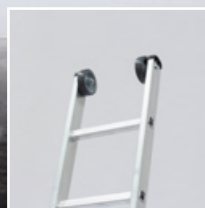
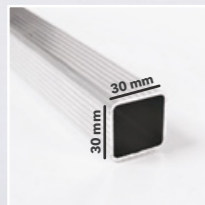
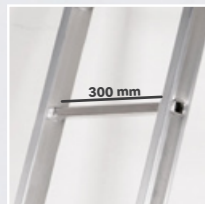

5604620500107	3x10	2,88m	6,80m	6,57m	7,76m	0,48m	0,19m	21,20kg	
5604620500121	3x12	3,44m	7,64m	7,38m	8,57m	0,48m	0,21m	26,28kg	
5604620500145	3x14	4,00m	9,32m	9,01m	10,20m	0,48m	0,24m	34,05kg	
5604620500169	3x16	4,56m	10,44m	10,09m	11,28m	0,48m	0,24m	38,34kg	

CORDA X3

Escada profissional de 3 lances extensível com corda em alumínio. Mecanismo de corda e rodas para facilitar a abertura da escada sem articulações laterais, prevenindo lesões na utilização do produto. Degrau antiderrapante confortável (30x30 mm) e largura interior da escada com 300 mm.

Aluminium professional 3 section extension ladder - rope operated. Rope mechanism and wheels to facilitate the opening of the ladder without side hinges, preventing injuries when using the product. Comfortable non-slip rung (30x30 mm) and inner width of the ladder 300 mm.

Échelle professionnelle coulissante à corde 3 plans en aluminium. Mécanisme à corde et roues pour faciliter l'ouverture de l'échelle sans articulations latérales, évitant les blessures lors de l'utilisation du produit. Échelons antidérapant confortable de (30x30 mm) et largeur intérieure de l'échelle de 300 mm.

Escalera profesional extensible 3 tramos con cuerda luminionio. Mecanismo de cuerda y ruedas para facilitar la apertura de la escalera sin bisagras laterales, evitando lesiones al utilizar el producto. Cómodo peldaño antideslizante de (30x30 mm) y ancho interior de la escalera de 300 mm.

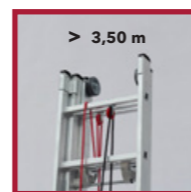

EN 131

PRO



REF	REF.6		REF.8		REF.10		REF.11	
1.00	1000x60x20mm	0,47kg	1000x80x20mm	0,59kg	1000x100x20mm	0,72kg	1000x110x20mm	1,11kg
1.50	1500x60x20mm	0,70kg	1500x80x20mm	0,88kg	1500x100x20mm	1,07kg	1500x110x20mm	1,66kg
2.00	2000x60x20mm	0,94kg	2000x80x20mm	1,17kg	2000x100x20mm	1,43kg	2000x110x20mm	2,21kg
2.50	2500x60x20mm	1,17kg	2500x80x20mm	1,47kg	2500x100x20mm	1,78kg	2500x110x20mm	2,76kg
3.00	3000x60x20mm	1,40kg	3000x80x20mm	1,76kg	3000x100x20mm	2,13kg	3000x110x20mm	3,30kg
3.50	3500x60x20mm	1,63kg	3500x80x20mm	2,05kg	3500x100x20mm	2,49kg	3500x110x20mm	3,85kg
4.00	4000x60x20mm	1,86kg	4000x80x20mm	2,34kg	4000x100x20mm	2,84kg	4000x110x20mm	4,40kg
5.00	5000x60x20mm	2,32kg	5000x80x20mm	2,92kg	5000x100x20mm	3,54kg	5000x110x20mm	5,50kg
6.00	6000x60x20mm	2,79kg	6000x80x20mm	3,50kg	6000x100x20mm	4,25kg	6000x110x20mm	6,60kg

RÉGUAS

Réguas de alumínio.

Aluminium rullers.

Règles en aluminium.

Regles de aluminio.



MASTER

Andaime modular profissional em alumínio. Construção soldada em tubos com diâmetro de 50,8 mm e espessura de 2 mm. Dimensão da plataforma 1670x600 mm, máxima estabilidade, com rodas giratórias e base dobrável. Montagem facilitada sem ferramentas.

Professional aluminium modular scaffold. Product developed in welded tubes with diameter 50,8 mm and thickness 2 mm. Platform dimension 1670x600 mm, increased stability, with castor wheels and folding base frame. Easy to assemble - no tools needed.

Échafaudage roulant professionnel en aluminium. Produit développé en tubes soudés de diamètre 50,8 mm et épaisseur 2 mm. Dimension plateforme 1670x600 mm, stabilité optimale, roues pivotantes et base pliante. Montage rapide et sans outil.

Andamio modular de aluminio profesional. Producto desarrollado en tubos soldados de 50,8 mm de diámetro y 2 mm de espesor. Dimensión plataforma 1670x600 mm, máxima estabilidad, con ruedas giratórias y base plegable. Fácil montaje (sin necesidad de herramientas).

OPÇÃO
OPTION | OPTION | OPCIÓN



EN 1004

PRO

PACKS E COMPONENTES

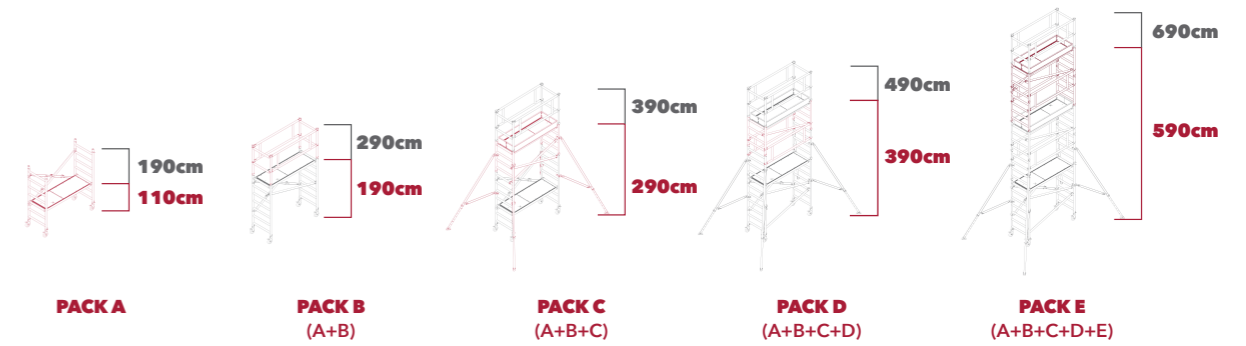

PACKS								
A	5604620040313	1,10m	3,10m	1,90m	1.85m	0.70m	210x23x78cm	39,47 kg
A+B	5604620040320	1,90m	3,90m	2,90m	1.85m	0.70m	210x36x78cm	56,31 kg
A+B+C	5604620040337	2,90m	4,90m	3,90m	1.85m	0.70m	210x55x78cm	111,90kg
A+B+C+D	5604620040344	3,90m	5,90m	4,90m	1.85m	0.70m	210x73x78cm	131,64kg
A+B+C+D+E	5604620040351	5,90m	7,90m	6,90m	1.85m	0.70m	210x104x78cm	184,22kg

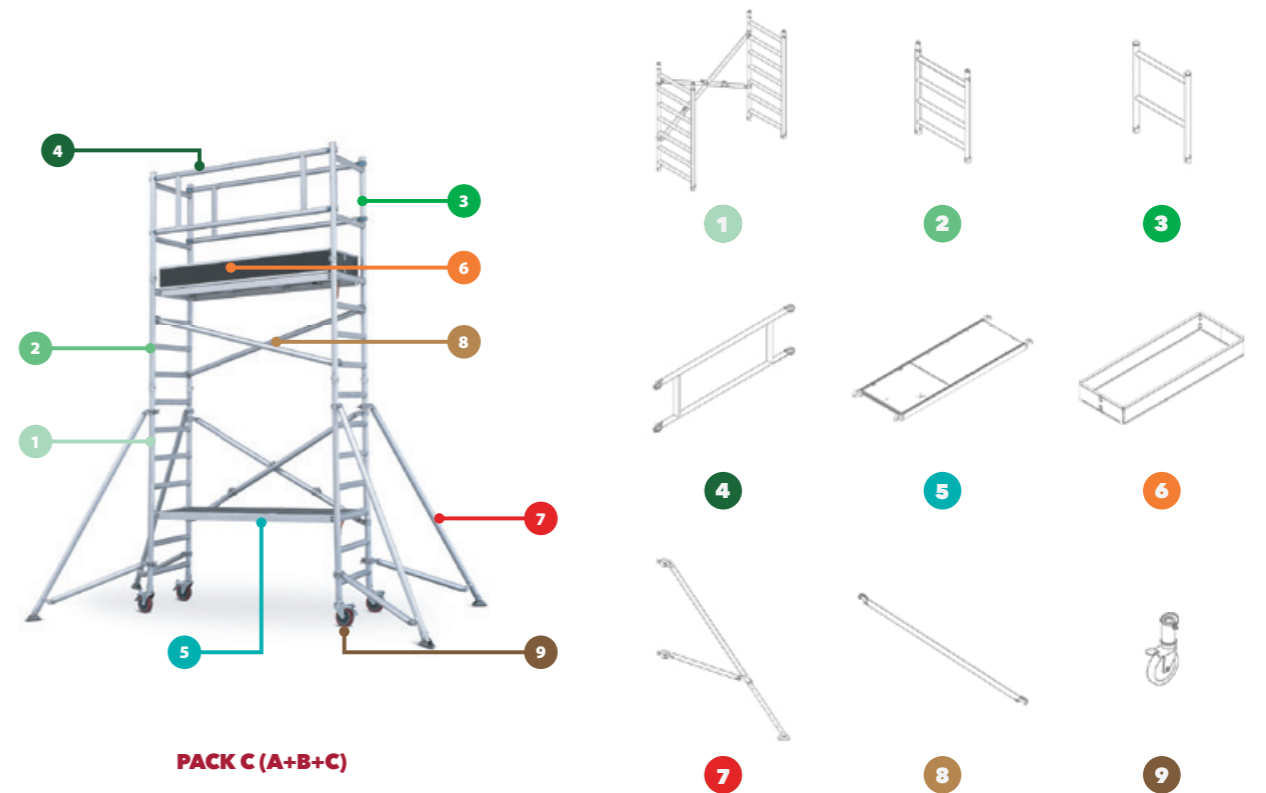

PACK C (A+B+C)



EXTREME 1350

Andaime modular profissional em alumínio com dupla plataforma de trabalho. Construção soldada em tubos com diâmetro de 50,8 mm e espessura de 2 mm. Dimensão da plataforma 2000x610 mm, máxima estabilidade, com rodas giratórias ajustáveis em altura e escada interior em alumínio disponível para acesso mais cómodo e seguro. Montagem facilitada sem ferramentas.

Professional aluminium modular scaffold with double work platform. Product developed in welded tubes with diameter 50,8 mm and thickness 2 mm. Platform dimension 2000x610 mm, increased stability, with height-adjustable castor wheels and internal rung ladder (aluminium) available for easy and safe access. Easy to assemble - no tools needed.

Échafaudage roulant professionnel en aluminium avec double plate-forme de travail. Produit développé en tubes soudés de diamètre 50,8 mm et épaisseur 2 mm. Dimension plateforme 2000x610 mm, stabilité optimale, avec roues pivotantes réglables en hauteur et l'accès se fait par l'intérieur en utilisant les échelles intégrées (aluminium) pour plus de sécurité et de confort. Montage rapide et sans outil.

Andamio modular de aluminio profesional con doble plataforma de trabajo. Producto desarrollado en tubos soldados de 50,8 mm de diámetro y 2 mm de espesor. Dimensión plataforma 2000x610 mm, máxima estabilidad, con ruedas giratorias de altura regulable y escalera interior de aluminio para subir de forma cómoda y segura. Fácil montaje (sin necesidad de herramientas).

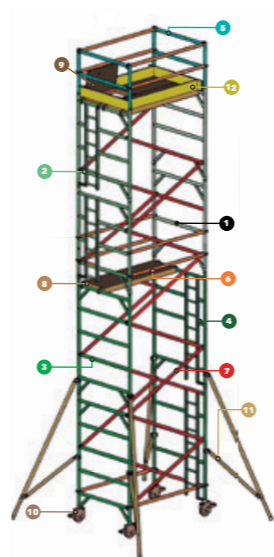

EN 1004

PRO

PACKS E COMPONENTES

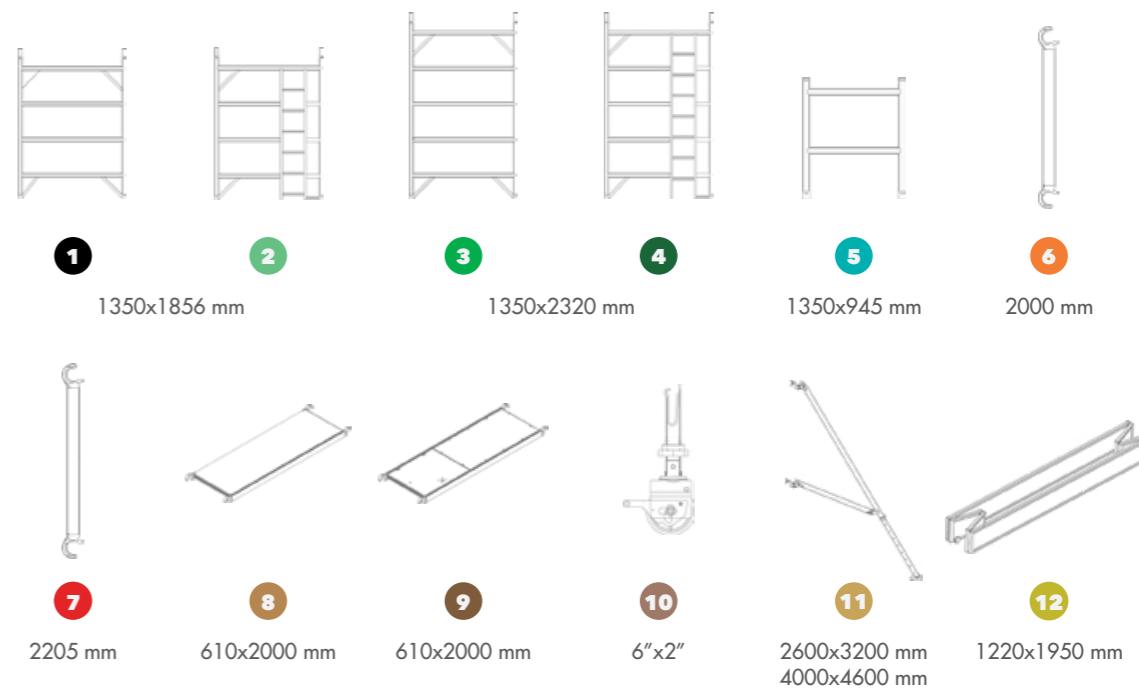

REF	Barcode	Icon 1	Icon 2	Icon 3	Icon 4	Icon 5	Icon 6	Icon 7
101	5604620041013	2,60m	4,60m	3,60m	2,00m	1,35m	146,42kg	
104	5604620041044	4,00m	6,00m	5,00m	2,00m	1,35m	169,05kg	
105	5604620042058	4,30m	6,30m	5,30m	2,00m	1,35m	174,56kg	
106	5604620041051	4,80m	6,80m	5,80m	2,00m	1,35m	184,85kg	
108	5604620041082	5,90m	7,90m	6,90m	2,00m	1,35m	221,92kg	
109	5604620041099	6,20m	8,20m	7,20m	2,00m	1,35m	227,43kg	
110	5604620041105	6,70m	8,70m	7,70m	2,00m	1,35m	237,72kg	
111	5604620041112	7,10m	9,10m	8,10m	2,00m	1,35m	243,23kg	
112	5604620041129	7,60m	9,60m	8,60m	2,00m	1,35m	250,06kg	
113	5604620041136	8,00m	10,00m	9,00m	2,00m	1,35m	255,57kg	
114	5604620041143	8,50m	10,50m	9,50m	2,00m	1,35m	265,86kg	
115	5604620041150	8,80m	10,80m	9,80m	2,00m	1,35m	271,37kg	
116	5604620041167	9,40m	11,40m	10,40m	2,00m	1,35m	281,66kg	
117	5604620041174	9,70m	11,70m	10,70m	2,00m	1,35m	308,44kg	
118	5604620041181	10,30m	12,30m	11,30m	2,00m	1,35m	318,73kg	
119	5604620041198	10,80m	12,80m	11,80m	2,00m	1,35m	324,24kg	
120	5604620041204	11,30m	13,30m	12,30m	2,00m	1,35m	355,57kg	
121	5604620041211	11,80m	13,80m	12,80m	2,00m	1,35m	361,08kg	
122	5604620041228	12,20m	14,20m	13,20m	2,00m	1,35m	363,13kg	
123	5604620041235	12,70m	14,70m	13,70m	2,00m	1,35m	373,42kg	
124	5604620041242	13,10m	15,10m	14,10m	2,00m	1,35m	383,71kg	



EXTREME 700

Andaime modular profissional em alumínio com dupla plataforma de trabalho. Construção soldada em tubos com diâmetro de 50,8 mm e espessura de 2 mm. Dimensão da plataforma 2000x610 mm, máxima estabilidade, com rodas giratórias ajustáveis em altura e escada interior em alumínio disponível para acesso mais cómodo e seguro. Montagem facilitada sem ferramentas.

Professional aluminium modular scaffold with double work platform. Product developed in welded tubes with diameter 50,8 mm and thickness 2 mm. Platform dimension 2000x610 mm, increased stability, with height-adjustable castor wheels and internal rung ladder (aluminium) available for easy and safe access. Easy to assemble - no tools needed.

Échafaudage roulant professionnel en aluminium avec double plate-forme de travail. Produit développé en tubes soudés de diamètre 50,8 mm et épaisseur 2 mm. Dimension plateforme 2000x610 mm, stabilité optimale, avec roues pivotantes réglables en hauteur et l'accès se fait par l'intérieur en utilisant les échelles intégrées (aluminium) pour plus de sécurité et de confort. Montage rapide et sans outil.

Andamio modular de aluminio profesional con doble plataforma de trabajo. Producto desarrollado en tubos soldados de 50,8 mm de diámetro y 2 mm de espesor. Dimensión plataforma 2000x610 mm, máxima estabilidad, con ruedas giratorias de altura regulable y escalera interior de aluminio para subir de forma cómoda y segura. Fácil montaje (sin necesidad de herramientas).

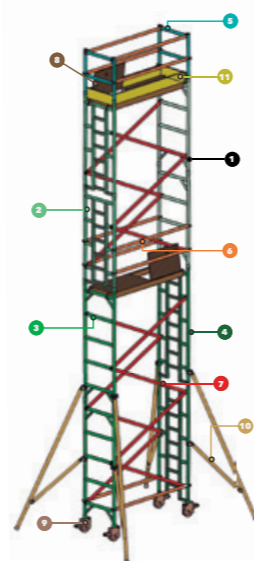

EN 1004

PRO

PACKS E COMPONENTES

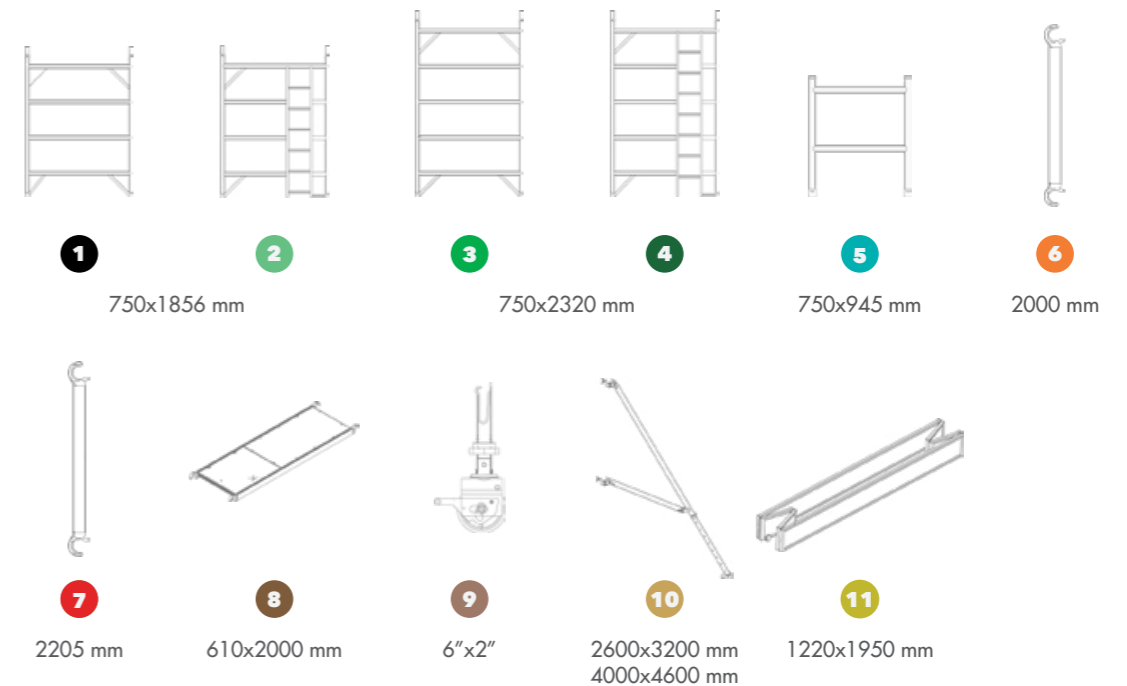

REF	Icon 1	Icon 2	Icon 3	Icon 4	Icon 5	Icon 6	Icon 7
201	5604620042010	2,60m	4,60m	3,60m	2,00m	0,70m	121,54kg
204	5604620042041	4,00m	6,00m	5,00m	2,00m	0,70m	143,02kg
205	5604620042058	4,30m	6,30m	5,30m	2,00m	0,70m	146,29kg
206	5604620042065	4,80m	6,80m	5,80m	2,00m	0,70m	154,34kg
208	5604620042089	5,90m	7,90m	6,90m	2,00m	0,70m	187,85kg
209	5604620042096	6,20m	8,20m	7,20m	2,00m	0,70m	191,12kg
210	5604620042102	6,70m	8,70m	7,70m	2,00m	0,70m	199,17kg
211	5604620042119	7,10m	9,10m	8,10m	2,00m	0,70m	202,44kg
212	5604620042126	7,60m	9,60m	8,60m	2,00m	0,70m	212,60kg
213	5604620042133	8,00m	10,00m	9,00m	2,00m	0,70m	215,87kg
214	5604620042140	8,50m	10,50m	9,50m	2,00m	0,70m	223,92kg
215	5604620042157	8,80m	10,80m	9,80m	2,00m	0,70m	227,19kg
216	5604620042164	9,40m	11,40m	10,40m	2,00m	0,70m	235,24kg
217	5604620042171	9,70m	11,70m	10,70m	2,00m	0,70m	260,70kg
218	5604620042188	10,30m	12,30m	11,30m	2,00m	0,70m	268,75kg
219	5604620042195	10,80m	12,80m	11,80m	2,00m	0,70m	272,02kg
220	5604620042201	11,30m	13,30m	12,30m	2,00m	0,70m	301,11kg
221	5604620042218	11,80m	13,80m	12,80m	2,00m	0,70m	304,38kg
222	5604620042225	12,20m	14,20m	13,20m	2,00m	0,70m	314,54kg
223	5604620042232	12,70m	14,70m	13,70m	2,00m	0,70m	317,81kg
224	5604620042249	13,10m	15,10m	14,10m	2,00m	0,70m	325,86kg



ENERGY

Produto leve com grande resistência.

Lightweight but very strong product.

Produit léger à haute résistance.

Producto ligero con alta resistencia.

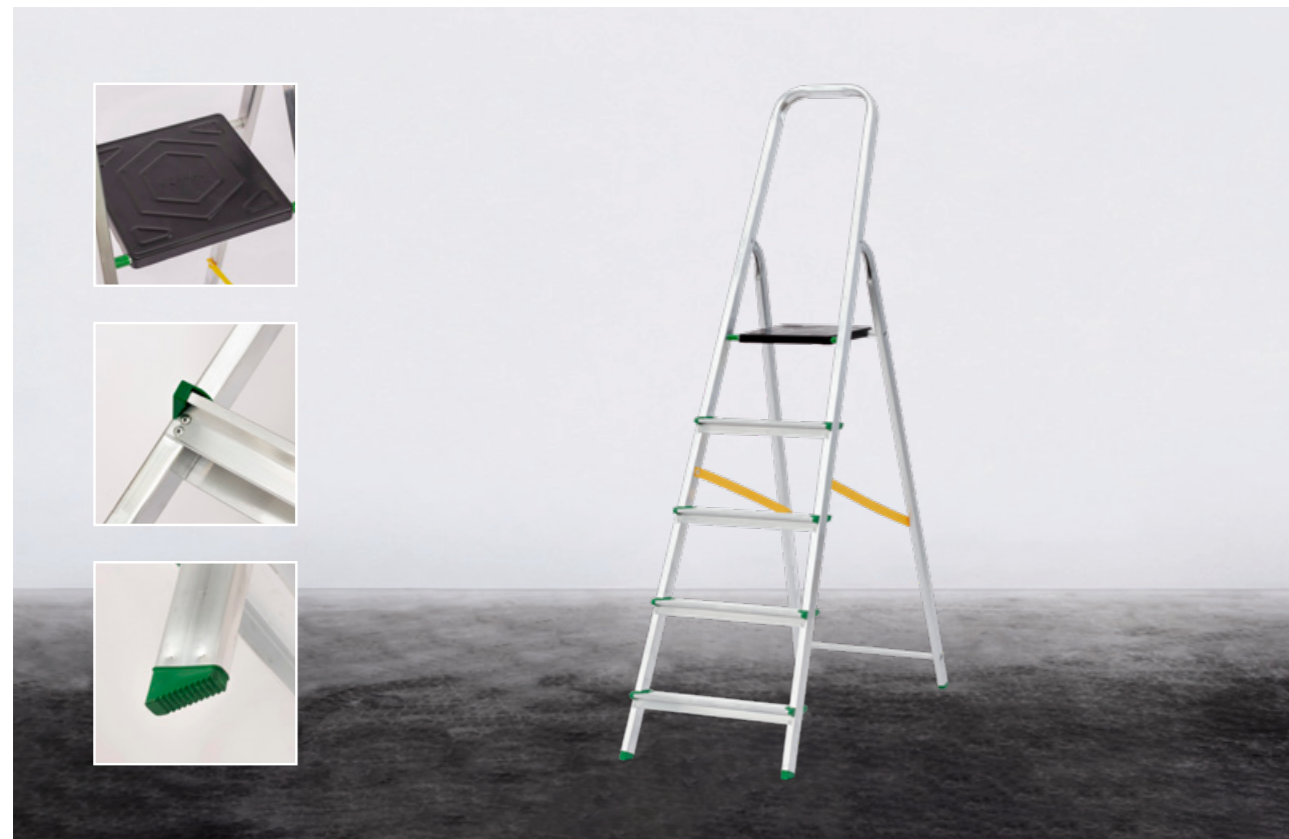

Barcode	Steps	Platform Height	Platform Width	Step Height	Step Depth	Step Width	Step Spacing	Step Length	Weight
5604620010620	2	0,36m	2,36m	0,97m	0,38m	1,05m	0,12m	2,48kg	
5604620010637	3	0,56m	2,56m	1,17m	0,40m	1,28m	0,12m	3,04kg	
5604620010644	4	0,67m	2,67m	1,38m	0,43m	1,51m	0,12m	3,62kg	
5604620010651	5	0,98m	2,98m	1,59m	0,45m	1,74m	0,12m	4,23kg	
5604620010668	6	1,19m	3,19m	1,81m	0,48m	1,97m	0,12m	4,93kg	
5604620010675	7	1,40m	3,40m	2,01m	0,50m	2,20m	0,13m	5,84kg	
5604620010682	8	1,61m	3,61m	2,22m	0,52m	2,43m	0,13m	6,51kg	

CLASSIK

Escadote em alumínio para utilização bricolage (DIY). Plataforma lacada sem superfícies cortantes, degraus estriados antiderrapantes com duplo rebite e arco de segurança. Cintas de segurança a partir de 5 degraus e pés antiderrapantes.

Aluminium stepladder for do-it-yourself (DIY). Non-slip powder coated platform free of sharp edges, double-rivet steps with non-slip ribbed surface and safety rail. Safety straps from 5 steps and slip-resistant feet.

Escabeau en aluminium pour utilisation bricolage (DIY). Plateforme laqué sans arêtes vives, marches à double rivet avec stries antidérapantes et garde-corps. Sangles de sécurité à partir du 5 marches et sabot emboîtable antidérapant.

Escala de aluminio para uso bricolaje (DIY). Plataforma lacada sin bordes afilados, peldaños estriados antideslizantes con doble remache y arco de seguridad. Cintas de seguridad a partir de 5 peldaños y tacos antideslizantes.

OPÇÃO
OPCIÓN | OPTION | OPCION



EN 131

BRICO



Barcode	Steps	Platform Height	Platform Width	Step Height	Step Depth	Step Width	Step Spacing	Step Length	Weight
5604620010323	2	0,35m	2,35m	0,96m	0,38m	1,09m	0,12m	2,61kg	
5604620010330	3	0,56m	2,56m	1,17m	0,40m	1,32m	0,12m	3,17kg	
5604620010347	4	0,77m	2,77m	1,38m	0,43m	1,55m	0,12m	3,75kg	
5604620010354	5	0,98m	2,98m	1,59m	0,45m	1,78m	0,12m	4,38kg	
5604620010361	6	1,19m	3,19m	1,80m	0,48m	2,01m	0,12m	5,06kg	
5604620010378	7	1,40m	3,40m	2,01m	0,50m	2,24m	0,12m	5,96kg	
5604620010385	8	1,61m	3,61m	2,22m	0,52m	2,47m	0,12m	6,62kg	

PLUS

Escadote em alumínio para utilização bricolage (DIY) com porta ferramentas. Plataforma lacada sem superfícies cortantes, degraus estriados antiderrapantes com duplo rebite e arco de segurança. Cintas de segurança a partir de 5 degraus e pés antiderrapantes.

Aluminium stepladder for do-it-yourself (DIY) with tool holder. Non-slip powder coated platform free of sharp edges, double-rivet steps with non-slip ribbed surface and safety rail. Safety straps from 5 steps and slip-resistant feet.

Escabeau en aluminium pour utilisation bricolage (DIY) avec porte-outils. Plateforme laqué sans arêtes vives, marches à double rivet avec stries antidérapantes et garde-corps. Sangles de sécurité à partir du 5 marches et sabot emboîtable antidérapant.

Escala de aluminio para uso bricolaje (DIY) con porta-herramientas. Plataforma lacada sin bordes afilados, peldaños estriados antideslizantes con doble remache y arco de seguridad. Cintas de seguridad a partir de 5 peldaños y tacos antideslizantes.

OPÇÃO
OPCIÓN | OPTION | OPCION



EN 131

BRICO

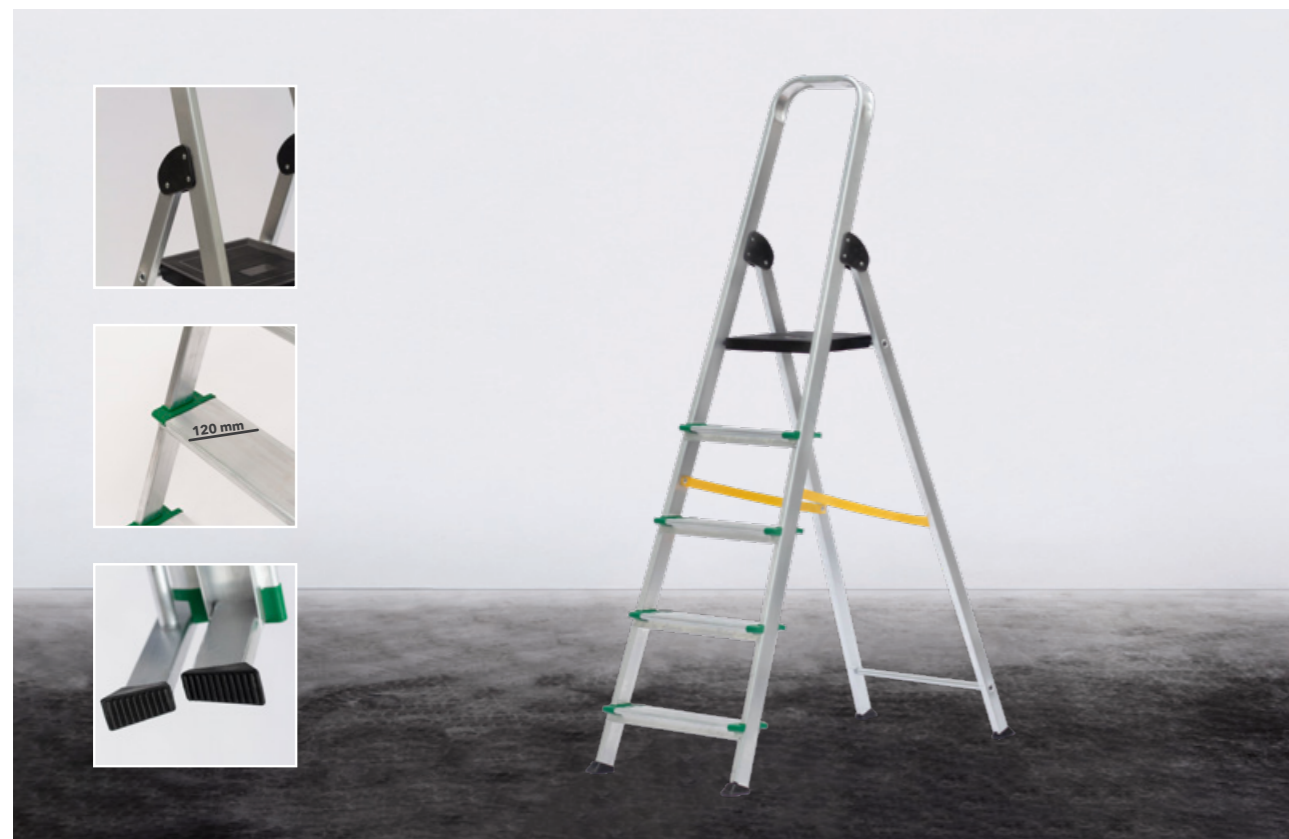

	Icon 1	Icon 2	Icon 3	Icon 4	Icon 5	Icon 6	Icon 7	Icon 8	Icon 9
5604620010538	3	0,57m	2,57m	1,20m	0,41m	1,20m	0,14m	3,78kg	
5604620010545	4	0,79m	2,79m	1,41m	0,45m	1,51m	0,14m	4,57kg	
5604620010552	5	1,02m	3,02m	1,63m	0,48m	1,74m	0,14m	5,42kg	
5604620010569	6	1,23m	3,23m	1,84m	0,50m	1,89m	0,14m	6,34kg	
5604620010576	7	1,44m	3,44m	2,06m	0,53m	2,20m	0,14m	7,20kg	
5604620010583	8	1,65m	3,65m	2,27m	0,59m	2,43m	0,14m	8,08kg	

SUPER

Escadote reforçado em alumínio. Degraus estriados antiderrapantes com largura de 120 mm e duplo rebite. Plataforma lacada sem superfícies cortantes e arco de segurança. Cintas de segurança a partir de 5 degraus e pés antiderrapantes.

Aluminium heavy-duty stepladder. Deep tread steps (120 mm) with non-slip ribbed surface and double-rivet. Non-slip powder coated platform free of sharp edges and safety rail. Safety straps from 5 steps and slip-resistant feet.

Escabeau solide en aluminium. Marches larges (120 mm) à double rivet avec stries antidérapantes. Plateforme laquée sans arêtes vives et garde-corps. Sangles de sécurité à partir du 5 marches et sabot emboîtable antidérapant.

Escalera de aluminio reforzada. Peldaños anchos (120 mm) estriados antideslizantes con doble remache. Plataforma lacada sin bordes afilados y arco de seguridad. Cintas de seguridad a partir de 5 peldaños y tacos antideslizantes.

OPÇÃO
OPCIÓN | OPTION | OPCION



EN 131

PRO



	Icon 1	Icon 2	Icon 3	Icon 4	Icon 5	Icon 6	Icon 7	Icon 8	Icon 9
5604620022531	3	0,14m	2,14m	0,65m	0,41m	0,70m	0,16m	3,16kg	
5604620022548	4	0,38m	2,38m	0,90m	0,44m	0,96m	0,16m	4,16kg	
5604620022555	5	0,62m	2,62m	1,14m	0,46m	1,22m	0,16m	5,34kg	
5604620022562	6	0,86m	2,86m	1,39m	0,49m	1,48m	0,16m	6,41kg	
5604620022579	7	1,10m	3,10m	1,63m	0,51m	1,74m	0,16m	7,49kg	
5604620022586	8	1,34m	3,34m	1,88m	0,54m	2,00m	0,16m	8,61kg	

DUPLO

Escadote em alumínio de duplo acesso. Degraus estriados antiderrapantes com duplo rebite e dispositivo de segurança antiabertura. Cintas de segurança e pés antiderrapantes.

Aluminium double-sided stepladder. Double-rivet steps with non-slip ribbed surface and safety locking mechanism. Safety straps from 5 steps and slip-resistant feet.

Escabeau double accès en aluminium. Marches à double rivet avec stries antidérapantes et mécanisme de verrouillage de sécurité. Sangles de sécurité et sabot emboîtable antidérapant.

Escalera de aluminio de doble acceso. Peldaños estriados antideslizantes con doble remache y bloqueo de seguridad. Cintas de seguridad y tacos antideslizantes.



EN 131

BRICO



Barcode	Steps	Height (m)	Width (m)	Depth (m)	Platform (m)	Step (m)	Step (m)	Weight (kg)
5604620025129	2	0,47m	2,47m	0,87m	0,48m	0,95m	0,09m	4,70kg
5604620025136	3	0,72m	2,72m	1,12m	0,48m	1,22m	0,09m	6,50kg
5604620025143	4	0,97m	2,97m	1,37m	0,48m	1,49m	0,09m	8,50kg

CONFORTO

Escadote extra-largo com arco de segurança. Plataformas alargadas antiderrapantes (265x385 mm), estabilidade reforçada e dispositivo de segurança antiabertura. Facilidade de transporte e arrumação.

Extra-large folding stepladder with safety rail. Large non-slip rubber steps (265x385 mm), increased stability and safety locking mechanism. Easy transport and storage.

Marchepied extra-large avec garde corps. Marches de grande dimension avec tapis antidérapants (265x385 mm), stabilité renforcée et mécanisme de verrouillage de sécurité. Transporte et stockage aisé.

Escalera extra-ancha con arco de seguridad. Peldaños anchos antideslizantes (265x385 mm), estabilidad reforzada y bloqueo de seguridad. Fácil almacenamiento y transporte.



EN 131

DOM



Barcode	Steps	Height (m)	Width (m)	Depth (m)	Platform (m)	Step (m)	Step (m)	Weight (kg)
5604620002939	3	0,60m	2,60m	0,44m	0,78m	0,17m		2,92kg

DELUX

Banco escadote em alumínio. Plataforma ampla (265x385 mm), degraus estriados antiderrapantes com duplo rebite e dispositivo de segurança antiabertura. Cintas de segurança e pés antiderrapantes. Facilidade de transporte e arrumação.

Aluminium step stool. Large standing platform (265x385 mm), double-rivet steps with non-slip ribbed surface and safety locking mechanism. Safety straps and slip-resistant feet. Easy transport and storage.

Tabouret en aluminium. Large plateforme (265x385 mm), marches à double rivet avec stries antidérapantes et mécanisme de verrouillage de sécurité. Sangles de sécurité et sabot emboîtable antidérapant. Transporte et stockage aisé.

Taburete plegable ligero de aluminio. Plataforma ancha (265x385 mm), peldaños estriados antideslizantes con doble remache y bloqueo de seguridad. Cintas de seguridad y tacos antideslizantes. Fácil almacenamiento y transporte.



EN 14183

DOM



	Icon 1	Icon 2	Icon 3	Icon 4	Icon 5	Icon 6	Icon 7	Icon 8	Icon 9	Icon 10	Icon 11	Icon 12
5604620001239	3+3	0,92m	2,87m	2,77m	3,96m	1,49m	1,44m	2,63m	0,73m	0,21m	9,06kg	
5604620001208	3+4	1,20m	3,43m	3,31m	4,50m	1,77m	1,71m	2,90m	0,73m	0,21m	9,91kg	
5604620001246	4+4	1,48m	3,99m	3,85m	5,04m	2,05m	1,98m	3,17m	0,73m	0,21m	10,97kg	

ARTICULADA

Escada articulada telescópica em alumínio. Utilizável em 3 posições diferentes: escada extensível, posição de escadote e em superfícies desniveladas. Degrau antiderrapante confortável (30x30 mm) e largura interior da escada com 285 mm. Articulações Multiusos sistema de bloqueio da parte deslizante e tacos antiderrapantes. Base alargada para maior estabilidade.

Aluminium multi-purpose telescopic ladder. Ladder can be used in 3 different positions: extension ladder position, standing position and working on uneven ground. Comfortable non-slip rung (30x30 mm) and inner width of the ladder 285 mm. Multiusos hinges, sliding mechanism with locks and slip-resistant feet. Wider base to improve stability.

Échelle pliante télescopique en aluminium. Utilisable en 3 positions différentes: échelle simple, autostable et en dénivelés. Échelons antidérapant confortable de (30x30 mm) et largeur intérieure de l'échelle de 285 mm. Articulation Multiusos, système de blocage du plan coulissant et sabots antidérapants. Base évasée pour une meilleure stabilité.

Escalera telescópica multifunción profesional de aluminio. La escalera se puede cambiar en 3 posiciones diferentes: extensible, tijera y para trabajo en desnivel. Cómodo peldaño antideslizante de (30x30 mm) y ancho interior de la escalera de 285 mm. Bisagras Multiusos, sistema de posicionamiento con agarre y patas antideslizantes. Base ancha para alta estabilidad.



EN 131

PRO



	Icon 1	Icon 2	Icon 3	Icon 4	Icon 5	Icon 6	Icon 7	Icon 8	Icon 9	Icon 10	Icon 11	Icon 12	Icon 13	Icon 14	Icon 15	Icon 16
5604620021503	4x3	0,94m	3,47m	3,35m	4,54m	1,75m	1,69m	2,87m	0,93m	2,93m	0,33m	0,25m	14,94kg			

MULTIUSOS

Escada multifunções em alumínio com plataforma. Utilizável em 3 posições diferentes: escada extensível, posição de escadote e bancada de trabalho (1400x290 mm). Degrau antiderrapante confortável (30x30 mm) e largura interior da escada com 285 mm. Articulações Multiusos e estabilizador antiderrapante.

Aluminium multi-purpose ladder with platform. Ladder can be used in 3 different positions: extension ladder position, standing position and work platform (1400x290 mm). Comfortable non-slip rung (30x30 mm) and inner width of the ladder 285 mm. Multiusos hinges and slip-resistant cross-beam.

Échelle multi positions en aluminium avec plateforme. Utilisable en 3 positions différentes: échelle simple, autostable et plateforme de travail (1400x290 mm). Échelons antidérapant confortable de (30x30 mm) et largeur intérieure de l'échelle de 285 mm. Articulation Multiusos et embase stabilisatrice antidérapant.

Escalera multifuncional de aluminio con plataforma. La escalera se puede cambiar en 3 posiciones: extensible, tijera y plataforma de trabajo (1400x290 mm). Cómodo peldaño antideslizante de (30x30 mm) y ancho interior de la escalera de 285 mm Bisagras Multiusos y patas antideslizantes.

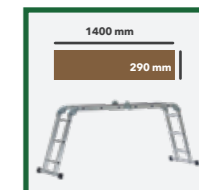
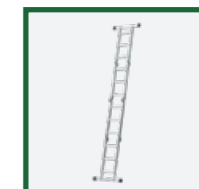

EN 131

BRICO



Barcode	Stairs	Length	Width	Height	Step Height	Step Width	Foot Height	Storage Length	Weight
5604620001383	9	2,61m	2,52m	3,65m	0,45m	0,74m	0,07m	77x49x9cm	6,70kg
5604620001390	13	3,81m	3,68m	4,81m	0,47m	0,86m	0,09m	89x52x10cm	10,70kg

TELESCÓPICA

Escada telescópica em alumínio. Degrau antiderrapante confortável 40 x 40 mm. Tacos antiderrapante. Facilidade de transporte e arrumação.

Aluminium telescopic ladder. Comfortable non-slip rung 40 x 40 mm. Slip-resistant feet. Easy transport and storage.

Échelle télescopique en aluminium. Échelons antidérapant confortable de 40 x 40 mm. Sabots antidérapants. Transporte et stockage aisé.

Escalera telescópica de aluminio. Cómodo peldaño antideslizante de 40 x 40 mm. Patas antideslizantes. Fácil transporte y almacenamiento.

EN 131

DOM



Barcode	Stairs	Length	Width	Height	Step Height	Step Width	Weight
5604620125065	6	1,76m	1,70m	2,89m	0,34m	52mm	2,70kg
5604620125072	7	2,04m	1,97m	3,16m	0,34m	52mm	3,10kg
5604620125089	8	2,32m	2,25m	3,43m	0,34m	52mm	3,49kg
5604620125096	9	2,60m	2,52m	3,70m	0,34m	52mm	3,89kg
5604620125102	10	2,88m	2,79m	3,97m	0,34m	52mm	4,29kg
5604620125126	12	3,44m	3,33m	4,52m	0,34m	58mm	5,96kg
5604620125140	14	4,00m	3,87m	5,06m	0,34m	58mm	6,81kg

TREK X1

Escada simples, de 1 lance, em alumínio. Degrau antiderrapante confortável (25x25 mm) e largura interior da escada com 290 mm. Tacos antiderrapantes e estabilizador de segurança (antiderrapante) a partir de 12 degraus.

Aluminium single section rung ladder. Comfortable non-slip rung (25x25 mm) and inner width of the ladder 290 mm. Slip-resistant feet and safety cross-beam (slip-resistant) from 12 rungs.

Échelle simple 1 plan en aluminium. Échelons antidérapant confortable (25x25 mm) et largeur intérieure de l'échelle de 290 mm. Sabots antidérapants et embase stabilisatrice (antidérapant) pour plus de sécurité dès 12 échelons.

Escalera industrial de aluminio simple de 1 tramo. Cómodo peldaño antideslizante (25x25 mm) y ancho interior de la escalera de 290 mm. Patas antideslizantes y base estabilizadora (antideslizante) de seguridad a partir de 12 peldaños.



EN 131

PRO



	Icon 1	Icon 2	Icon 3	Icon 4	Icon 5	Icon 6	Icon 7	Icon 8	Icon 9	Icon 10	Icon 11	Icon 12
5604620225062	2x6	1,76m	2,88m	2,79m	3,97m	1,76m	1,70m	2,89m	0,40m	110mm	6,78kg	
5604620225079	2x7	2,04m	3,44m	3,33m	4,52m	2,04m	1,97m	3,16m	0,40m	110mm	7,60kg	
5604620225086	2x8	2,32m	3,72m	3,60m	4,79m	2,32m	2,25m	3,43m	0,40m	110mm	8,46kg	
5604620225093	2x9	2,60m	4,00m	3,87m	5,06m	2,60m	2,52m	3,70m	0,40m	115mm	9,52kg	
5604620225109	2x10	2,88m	4,56m	4,41m	5,60m	2,88m	2,79m	3,97m	0,40m	120mm	10,72kg	
5604620225123	2x12	3,44m	5,68m	5,49m	6,68m	3,44m	3,33m	4,52m	0,40m	130mm	13,28kg	

TREK X2

Escada transformável de 2 lances em alumínio. Mecanismo de fácil utilização para transformar a escada em posição de escadote. Degrau antiderrapante confortável (25x25 mm) e largura interior da escada com 290 mm. Estabilizador antiderrapante e cintas de segurança.

Aluminium 2 section combination ladder. Easy-to-use mechanism to transform the ladder in standing position. Comfortable non-slip rung (25x25 mm) and inner width of the ladder 290 mm. Slip-resistant cross-beam and safety straps.

Échelle transformable 2 plans en aluminium. Articulation facile à utiliser pour transformer l'échelle en position autostable. Échelons antidérapant confortable de (25x25 mm) et largeur intérieure de l'échelle de 290 mm. Embase stabilisatrice antidérapant et sangles de sécurité.

Escalera industrial transformable de aluminio de 2 tramos. Dispositivo fácil de utilizar para transformar la escalera en posición de tijera. Cómodo peldaño antideslizante de (25x25 mm) y ancho interior de la escalera de 290 mm. Base estabilizadora antideslizante y cintas de seguridad.

OPÇÃO OPTION | OPTION | OPCIÓN



TREK X2 LIGHT - SOB CONSULTA | UPON REQUEST | SUR DEMAND | BAJO CONSULTA.

EN 131

PRO



	Icon 1	Icon 2	Icon 3	Icon 4	Icon 5	Icon 6	Icon 7	Icon 8	Icon 9	Icon 10	Icon 11	Icon 12
5604620325069	3x6	1,76m	3,16m	3,06m	4,25m	2,60m	2,52m	3,70m	0,47m	140mm	10,39kg	
5604620325076	3x7	2,04m	3,72m	3,60m	4,79m	3,16m	3,06m	4,25m	0,47m	145mm	11,90kg	
5604620325083	3x8	2,32m	4,56m	4,41m	5,60m	3,72m	3,60m	4,79m	0,47m	145mm	13,22kg	
5604620325090	3x9	2,60m	5,40m	5,22m	6,41m	4,28m	4,14m	5,33m	0,47m	155mm	15,07kg	
5604620325106	3x10	2,88m	6,52m	6,30m	7,49m	4,84m	4,68m	5,87m	0,47m	180mm	17,86kg	

TREK X3

Escada transformável de 3 lances em alumínio. Degrau antiderrapante confortável (25x25 mm) e largura interior da escada com 290 mm. Mecanismo de fácil utilização para transformar a escada em posição de escadote. Estabilizador antiderrapante e cintas de segurança.

Aluminium 3 section combination ladder. Easy-to-use mechanism to transform the ladder in standing position. Comfortable non-slip rung (25x25 mm) and inner width of the ladder 290 mm. Slip-resistant cross-beam and safety straps.

Échelle transformable 3 plans en aluminium. Articulation facile à utiliser pour transformer l'échelle en position autostable. Échelons antidérapant confortable de (25x25 mm) et largeur intérieure de l'échelle de 290 mm. Embase stabilisatrice antidérapant et sangles de sécurité.

Escalera industrial transformable de aluminio de 3 tramos. Dispositivo fácil de utilizar para transformar la escalera en posición de tijera. Cómodo peldaño antideslizante de (25x25 mm) y ancho interior de la escalera de 290 mm. Base estabilizadora antideslizante y cintas de seguridad.

OPÇÃO OPTION | OPTION | OPCIÓN



TREK X3 LIGHT - SOB CONSULTA | UPON REQUEST | SUR DEMAND | BAJO CONSULTA.

EN 131

PRO

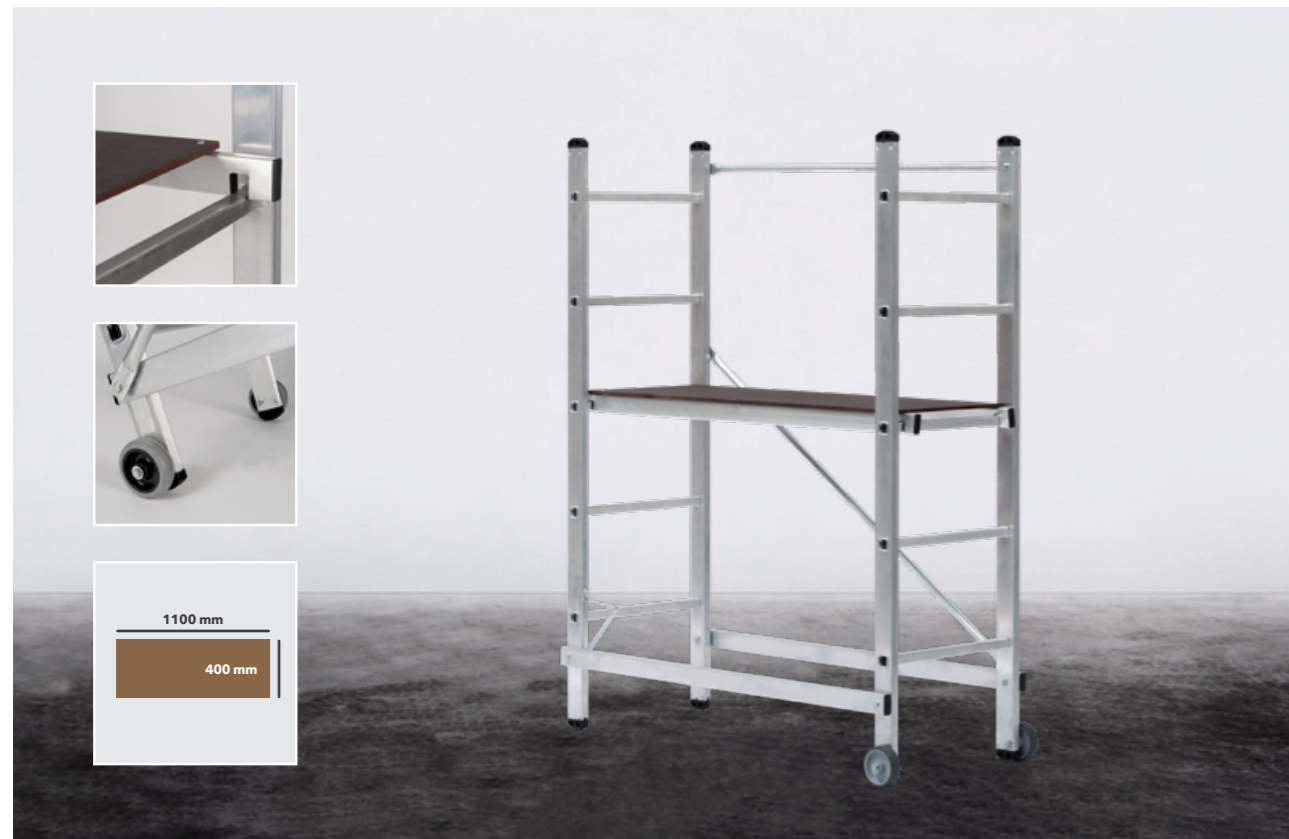

5604620111105	5+5	0,88m	3,00m	1,58m	1.14m	0.47m	170x53x16cm	11,73kg

HANDY

Andaime bricolage em alumínio. Solução versátil com 3 alturas de trabalho, dimensão da plataforma 1100x400 mm e equipado com rodas para facilitar o posicionamento. Montagem facilitada sem ferramentas.

DIY aluminium scaffold. Versatile solution with 3 working heights, platform dimension 1100x400 mm and equipped with wheels for easy positioning. Easy to assemble - no tools needed.

Échafaudage en aluminium pour une utilisation bricolage. Polyvalent avec 3 hauteurs de travail, dimension plateforme 1100x400 mm et roues pour un transport facile. Montage rapide et sans outil.

Andamio de aluminio para bricolaje. Versátil con 3 alturas de trabajo, dimensión plataforma 1100x400 mm y ruedas para cómodo posicionamiento. Fácil montaje (sin necesidad de herramientas).



2min.

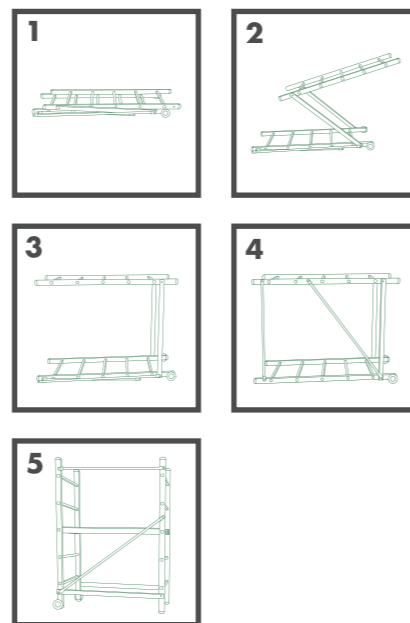

EN 131 BRICO

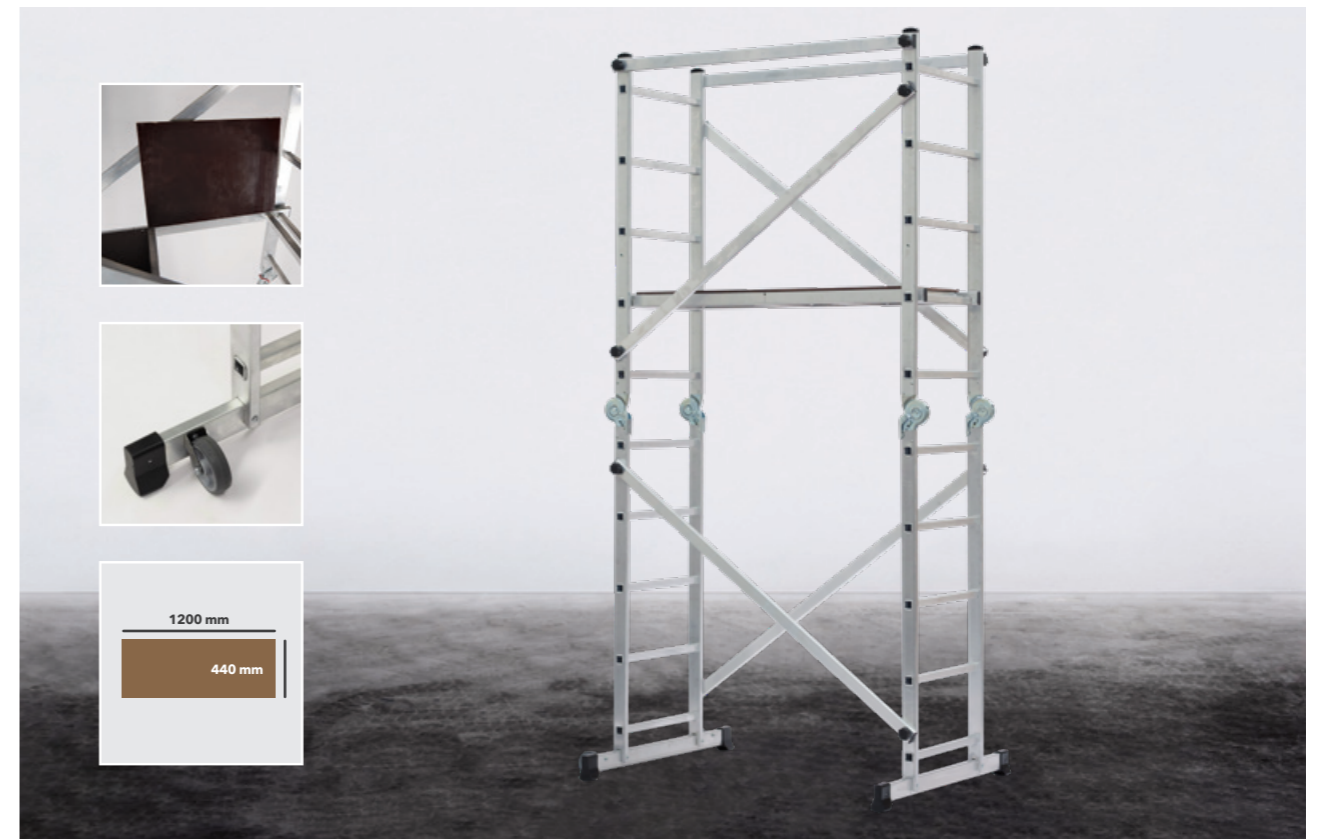

5604620111112	10+10	1,88m	4,00m	2,84m	1.34m	0.53m	148x52x33cm	26,54kg

COMBY

Andaime multifunções bricolage em alumínio. Utilizável em 3 posições diferentes: andaime, escada extensível e posição de escadote. Dimensão da plataforma (com alçapão) 1200x440 mm e equipado com rodas para facilitar o posicionamento. Montagem facilitada sem ferramentas.

DIY multi-purpose aluminium scaffold. Combi can be used in 3 different positions: scaffolding, extension ladder position and standing position. Platform (with hatch) dimension 1200x440 mm and equipped with wheels for easy positioning. Easy to assemble - no tools needed.

Échafaudage multi positions en aluminium pour une utilisation bricolage. Utilisable en 3 positions différentes: échafaudage, échelle simple et position autostable. Dimension plateforme (avec trappe) 1200x440 mm et roues pour un transport facile. Montage rapide et sans outil.

Andamio multifuncional de aluminio para bricolaje. Combi se puede cambiar en 3 posiciones: andamio, escalera extensible y tijera. Dimensión plataforma (con trampilla) 1200x440 mm y ruedas para cómodo posicionamiento. Fácil montaje (sin necesidad de herramientas).



5min.

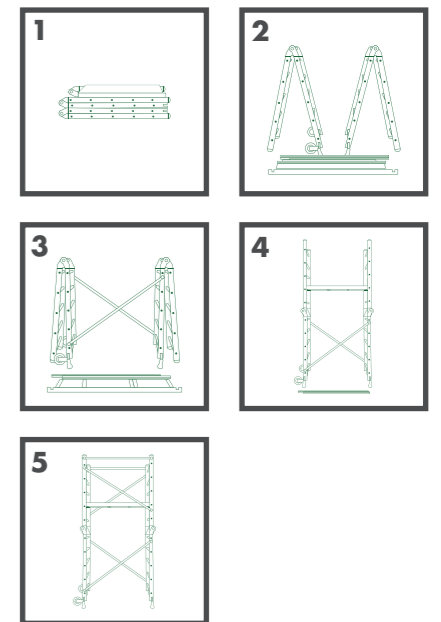

EN 131 BRICO



PACKS							
A	5604620040511	0,77m	2,77m	1,70m	1.34m	0.51m	24,79kg
A+B	5604620040528	2,45m	4,45m	3,38m	1.34m	0.51m	54,75kg
A+B+C	5604620040535	4,13m	6,13m	5,06m	1.34m	0.51m	74,16kg

DYNAMIC

Andaime modular em alumínio. Dimensão da plataforma (com alçapão) 1200x450 mm e equipado com rodas para facilitar o posicionamento. Estabilizadores incluídos a partir do pack B. Montagem facilitada sem ferramentas.

Modular aluminium scaffold. Platform (with hatch) dimension 1200x450 mm and equipped with wheels for easy positioning. Stabilizers included from pack B. Easy to assemble - no tools needed.

Échafaudage roulant en aluminium. Dimension plateforme (avec trappe) 1200x450 mm et roues pour un transport facile. Stabilisateurs inclus dans le pack B. Montage rapide et sans outil.

Andamio modular de aluminio. Dimensión plataforma (con trampilla) 1200x450 mm y ruedas para cómodo posicionamiento. Estabilizadores incluidos a partir del pack B. Fácil montaje (sin necesidad de herramientas).



10min.

EN 131

BRICO

PACKS

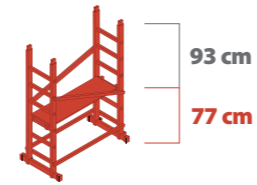

PACK A
25 kg

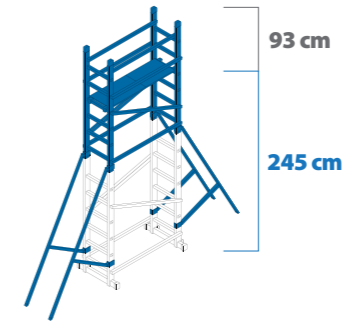

PACK B (A+B)
56 kg

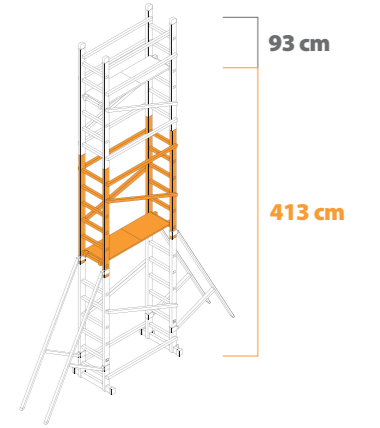

PACK C (A+B+C)
75 kg

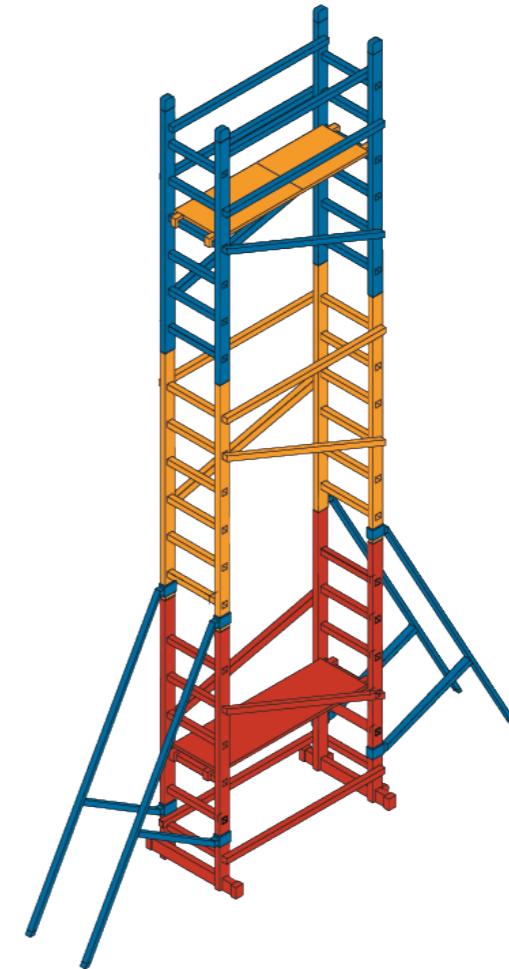



VOLT

A melhor escolha para trabalhos elétricos.

Best choice for electrical work.

Le meilleur choix pour les travaux électriques.

La mejor alternativa para trabajos eléctricos.

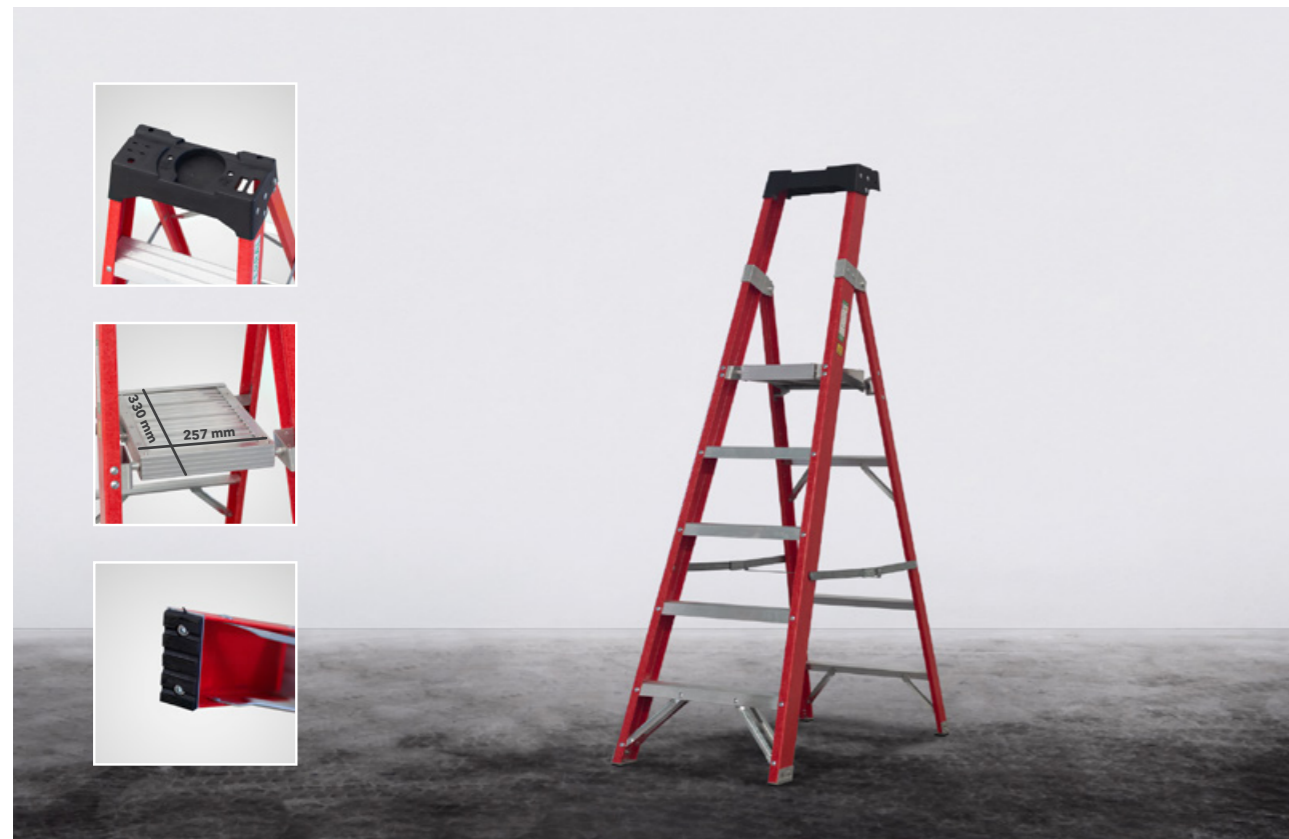

Barcode	Steps	Height	Width	Depth	Platform Length	Platform Width	Step Height	Weight
5604620160240	4	0,71m	2,71m	1,34m	0,42m	1,74m	0,15m	8,70kg
5604620160257	5	0,94m	2,94m	1,58m	0,47m	2,00m	0,15m	10,00kg
5604620160264	6	1,18m	3,18m	1,81m	0,52m	2,26m	0,15m	11,00kg
5604620160271	7	1,41m	3,41m	2,05m	0,57m	2,52m	0,15m	11,90kg

ELECTRA

Escadote profissional em fibra de vidro com arco de segurança. Plataforma ampla 330x257 mm e degraus estriados antiderrapantes. Porta ferramentas, cintas de segurança e pés antiderrapantes.

Professional fiberglass stepladder with safety rail. Large non-slip platform 330x257 mm and ribbed steps. Tool holder, safety straps and slip-resistant feet.

Escabeau professionnel en fibre de verre avec garde corps. Large plateforme 330x257 mm et marches striées antidérapants. Porte-outils, sangles de sécurité et sabot emboitable antidérapant.

Escalera profesional de fibra de vidrio con arco de seguridad. Plataforma ancha 330x257 mm y peldaños estriados antideslizantes. Bandeja porta-herramientas, cintas de seguridad y patas antideslizantes.

EN 131

PRO

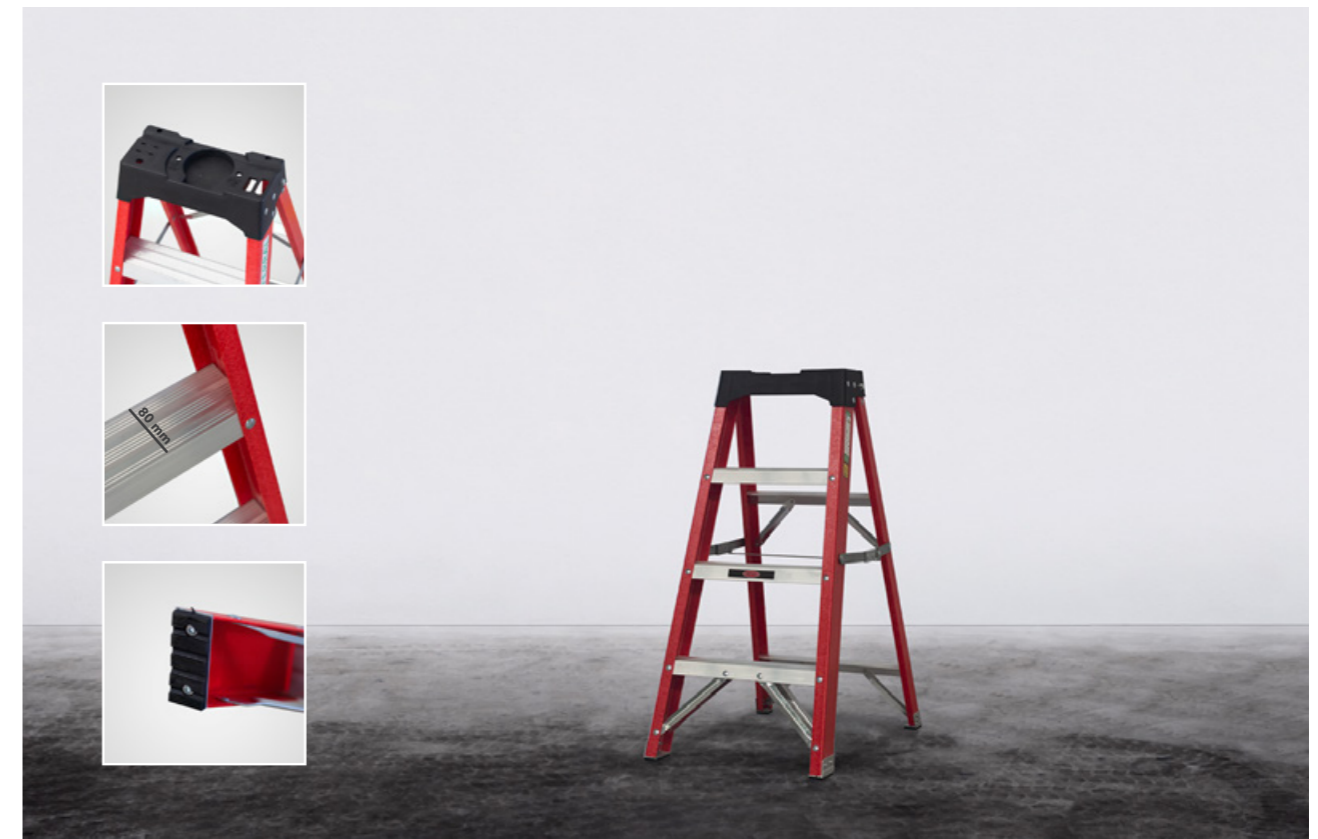

Barcode	Steps	Height	Width	Depth	Platform Length	Platform Width	Step Height	Weight
5604620160134	3	0,61m	2,61m	0,91m	0,38m	1,06m	0,15m	6,50kg
5604620160158	5	1,09m	3,09m	1,39m	0,47m	1,56m	0,15m	8,50kg
5604620160172	7	1,57m	3,57m	1,87m	0,56m	2,06m	0,15m	10,70kg
5604620160196	9	2,05m	4,05m	2,35m	0,65m	2,56m	0,15m	12,70kg

ELECTRA SINGLE

Escadote profissional em fibra de vidro. Degraus estriados antiderrapantes. Porta ferramentas, cintas de segurança e pés antiderrapantes.

Professional fiberglass stepladder. Non-slip ribbed steps. Tool holder, safety straps and slip-resistant feet.

Escabeau professionnel en fibre de verre. Marches striées antidérapants. Porte-outils, sangles de sécurité et sabot emboitable antidérapant.

Escalera profesional de fibra de vidrio. Peldaños estriados antideslizantes. Bandeja porta-herramientas, cintas de seguridad y patas antideslizantes.

EN 131

PRO

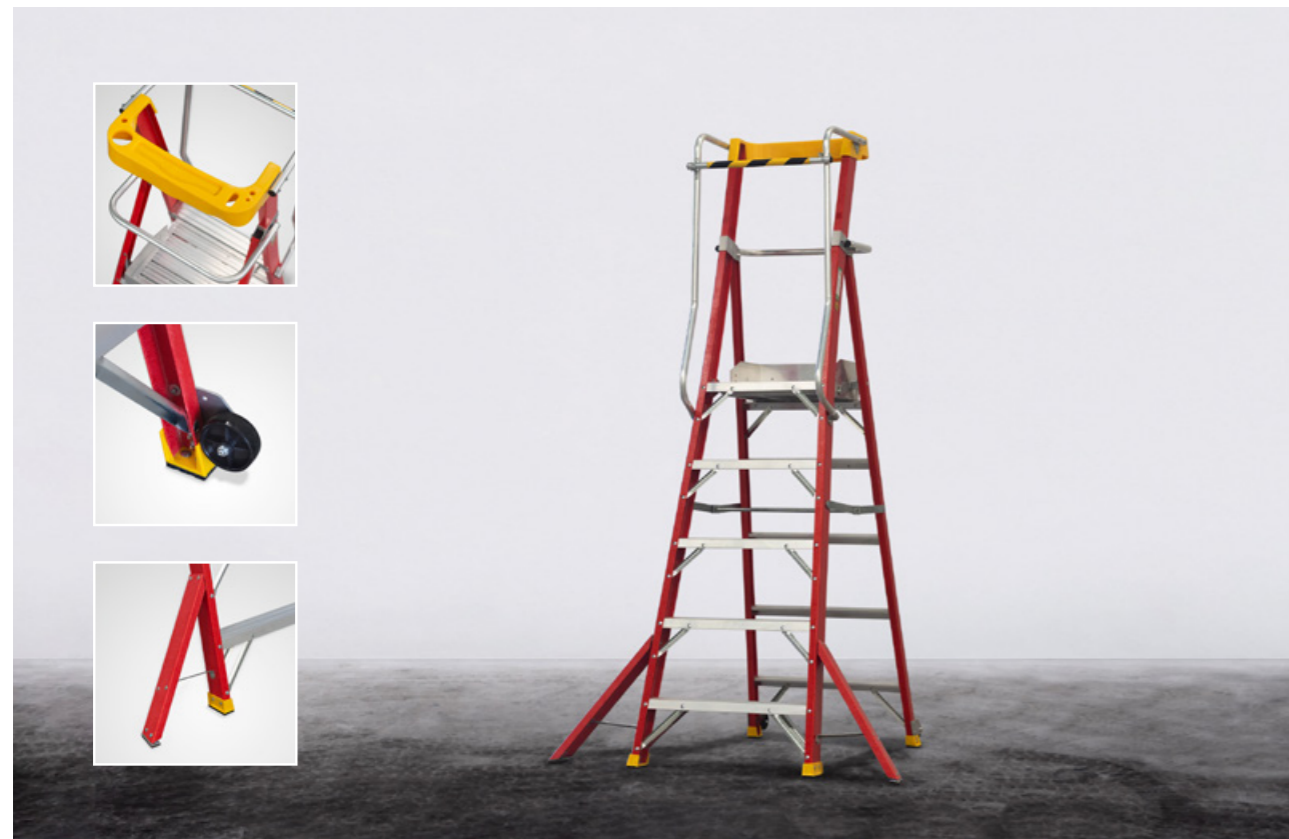

Barcode	Stairs	Height	Width	Depth	Platform	Length	Step	Weight
5604620160332	3	0,86m	2,86m	1,76m	0,65m	1,90m	0,24m	11,70kg
5604620160349	4	1,14m	3,14m	2,04m	0,69m	2,19m	0,24m	13,20kg
5604620160356	5	1,43m	3,43m	2,33m	0,72m	2,48m	0,24m	16,00kg
5604620160363	6	1,71m	3,71m	2,61m	0,76m	2,77m	0,24m	17,50kg

ELECTRA PROTECT

Plataforma profissional de trabalho portátil em fibra de vidro com guarda-corpos de segurança. Proteção traseira e porta ferramentas. Degraus estriados antiderrapantes e plataforma alargada (470x403 mm) para reforçar o conforto e a resistência do produto. Facilidade de transporte e arrumação.

Fiberglass professional mobile working platform with safety guardrails. Fall protection safety gates and toolholder. Non-slip ribbed steps and large platform (470x403 mm) to improve comfort and increase performance of the product. Easy transport and storage.

Plateforme Individuelle Roulante Légère (PIRL) professionnelle en fibre de verre avec garde-corps. Portillon de sécurité et porte-outils. Construction robuste avec marches striées antidérapants et plateforme de grande dimension (470x403 mm) pour améliorer le confort. Facile à transporter et à stocker.

Plataforma de trabajo móvil profesional de fibra de vidrio con barandillas de seguridad. Protección trasera y bandeja porta-herramientas. Peldaños estriados antideslizantes y plataforma ancha (470x403 mm) para máxima comodidad y reforzar al máximo la resistencia del producto. Fácil almacenamiento y transporte.

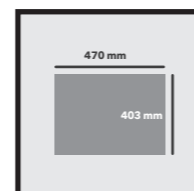

EN 131

PRO

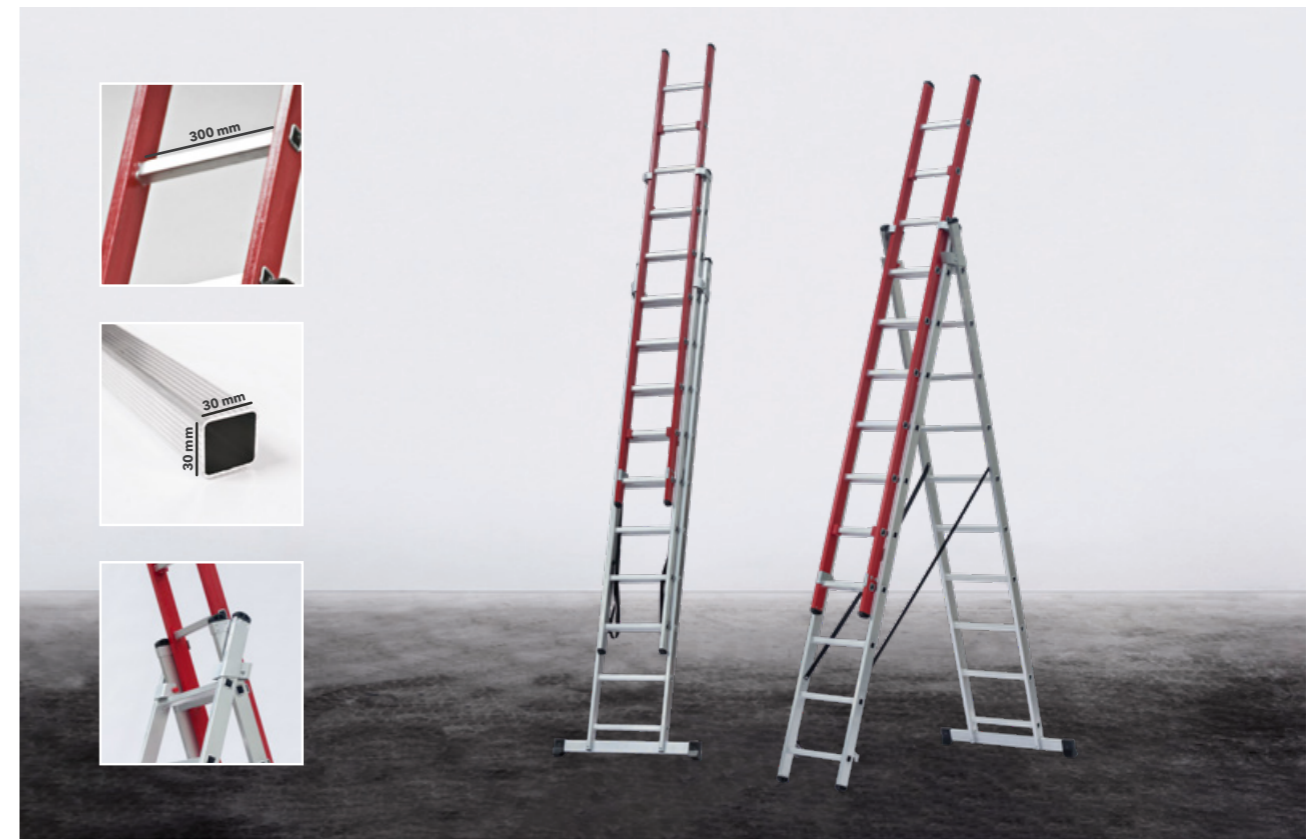

Barcode	Stairs	Height	Width	Depth	Platform	Length	Step	Weight			
5604620073106	3x10	2,88m	6,24m	6,03m	7,22m	4,84m	4,68m	5,87m	0,46m	0,18m	13,79kg

ELECTRA X3

Escada profissional transformável de 3 lance em alumínio e fibra de vidro. Mecanismo de fácil utilização para transformar a escada em posição de escadote. Degrau antiderrapante confortável (30x30 mm) e largura interior da escada com 300 mm. Estabilizador antiderrapante e cintas de segurança.

Professional aluminium and fiberglass 3 section combination ladder. Easy-to-use mechanism to transform the ladder in standing position. Comfortable non-slip rung (30x30 mm) and inner width of the ladder 300 mm. Slip-resistant cross-beam and safety straps.

Échelle professionnelle transformable 3 plans en aluminium et fibre de verre. Articulation facile à utiliser pour transformer l'échelle en position autostable. Échelons antidérapant confortable de (30x30 mm) et largeur intérieure de l'échelle de 300 mm. Embase stabilisatrice antidérapant et sangles de sécurité.

Escalera profesional industrial de aluminio y fibra de vidrio de 3 tramos. Dispositivo fácil de utilizar para transformar la escalera en posición de tijera. Cómodo peldaño antideslizante de (30x30 mm) y ancho interior de la escalera de 300 mm. Base estabilizadora antideslizante y cintas de seguridad.

OPÇÃO
OPTION | OPTION | OPCIÓN



ELECTRA X3 LIGHT - SOB CONSULTA | UPON REQUEST | SUR DEMAND | BAJO CONSULTA.

EN 131

PRO

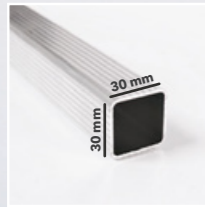

5604620113109	3x10	2,88m	6,24m	6,03m	7,22m	0,46m	0,18m	22,90kg

ELECTRA CORDA X3

Escada profissional de 3 lances extensível com corda em alumínio e fibra de vidro. Mecanismo de corda para facilitar a abertura da escada sem articulações laterais, prevenindo lesões na utilização do produto. Degrau antiderrapante confortável (30x30 mm) e largura interior da escada com 300 mm. Estabilizador de segurança antiderrapante.

Aluminium and fiberglass professional 3 section extension ladder - rope operated. Rope mechanism to facilitate the opening of the ladder without side hinges, preventing injuries when using the product. Comfortable non-slip rung (30x30 mm) and inner width of the ladder 300 mm. Slip-resistant safety cross-beam.

Échelle professionnelle coulissante à corde 3 plans en aluminium et fibre de verre. Mécanisme à corde pour faciliter l'ouverture de l'échelle sans articulations latérales, évitant les blessures lors de l'utilisation du produit. Échelons antidérapant confortable de (30x30 mm) et largeur intérieure de l'échelle de 300 mm. Embase stabilisatrice antidérapant pour plus de sécurité.

Escalera profesional extensible 3 tramos con cuerda de aluminio y fibra de vidrio. Mecanismo de cuerda para facilitar la apertura de la escalera sin bisagras laterales, evitando lesiones al utilizar el producto. Cómodo peldaño antideslizante de (30x30 mm) y ancho interior de la escalera de 300 mm. Base estabilizadora antideslizante de seguridad.

OPÇÃO
OPTION | OPTION | OPCION



EN 131

PRO

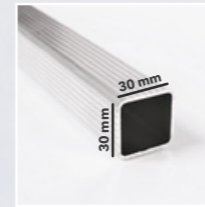
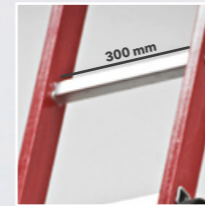

5604620121098	9	2,60m	2,52m	3,70m	0,35m	0,07m	7,07kg
5604620121104	10	2,88m	2,79m	3,97m	0,35m	0,07m	7,70kg
5604620121128	12	3,44m	3,33m	4,52m	0,35m	0,07m	8,92kg
5604620121142	14	4,00m	3,86m	5,06m	0,35m	0,07m	10,18kg

FIBRA X1

Escada profissional simples de 1 lance em fibra de vidro. Degrau antiderrapante confortável (30x30 mm) e largura interior da escada com 300 mm. Tacos antiderrapantes e estabilizador de segurança (antiderrapante) a partir de 12 degraus.

Aluminium fiberglass single section rung ladder. Comfortable non-slip rung (30x30 mm) and inner width of the ladder 300mm. Slip-resistant feet and safety cross-beam (slip-resistant) from 12 rungs.

Échelle professionnelle simple 1 plan en fibre de verre. Échelons antidérapant confortable de (30x30 mm) et largeur intérieure de l'échelle de 300 mm. Sabots antidérapants et embase stabilisatrice (antidérapant) pour plus de sécurité dès 12 échelons.

Escalera profesional industrial de fibra de vidrio simple de 1 tramo. Cómodo peldaño antideslizante de (30x30 mm) y ancho interior de la escalera de 300 mm. Patas antideslizantes y base estabilizadora (antideslizante) de seguridad a partir de 12 peldaños.



> 3,00 m

EN 131

PRO



	Icon 1	Icon 2	Icon 3	Icon 4	Icon 5	Icon 6	Icon 7	Icon 8	Icon 9	Icon 10	Icon 11	Icon 12
5604620132094	2x9	2,60m	4,28m	4,14m	5,33m	2,60m	2,52m	3,70m	0,41m	0,12m	14,30kg	
5604620132100	2x10	2,88m	4,84m	4,68m	5,87m	2,88m	2,79m	3,97m	0,41m	0,12m	15,59kg	
5604620132124	2x12	3,44m	5,96m	5,76m	6,95m	3,44m	3,33m	4,52m	0,41m	0,12m	18,18kg	
5604620132148	2x14	4,00m	7,08m	6,84m	8,03m	4,00m	3,87m	5,06m	0,41m	0,12m	20,79kg	

FIBRA X2

Escada profissional transformável de 2 lance em fibra de vidro. Mecanismo de fácil utilização para transformar a escada em posição de escadote. Degrau antiderrapante confortável (30x30 mm) e largura interior da escada com 300 mm. Estabilizador antiderrapante e cintas de segurança.

Aluminium fibreglass 2 section combination ladder. Easy-to-use mechanism to transform the ladder in standing position. Comfortable non-slip rung (30x30 mm) and inner width of the ladder 300 mm. Slip-resistant cross-beam and safety straps.

Échelle professionnelle transformable 2 plans en fibre de verre. Articulation facile à utiliser pour transformer l'échelle en position autostable. Échelons antidérapant confortable de (30x30 mm) et largeur intérieure de l'échelle de 300 mm. Embase stabilisatrice antidérapant et sangles de sécurité.

Escalera profesional industrial de fibra de vidrio de 2 tramos. Dispositivo fácil de utilizar para transformar la escalera en posición de tijera. Cómodo peldaño antideslizante de (30x30 mm) y ancho interior de la escalera de 300 mm. Base estabilizadora antideslizante y cintas de seguridad.

OPÇÃO
OPTION | OPTION | OPCION



EN 131

PRO



	Icon 1	Icon 2	Icon 3	Icon 4	Icon 5	Icon 6	Icon 7	Icon 8	Icon 9	Icon 10	Icon 11	Icon 12
5604620143090	3x9	2,60m	5,40m	5,22m	6,41m	4,00m	3,87m	5,06m	0,48m	0,16m	21,86kg	
5604620143106	3x10	2,88m	6,24m	6,03m	7,22m	4,56m	4,41m	5,60m	0,48m	0,16m	23,17kg	

FIBRA X3

Escada profissional transformável de 3 lance em fibra de vidro. Mecanismo de fácil utilização para transformar a escada em posição de escadote. Degrau antiderrapante confortável (30x30 mm) e largura interior da escada com 300 mm. Estabilizador antiderrapante e cintas de segurança.

Aluminium fibreglass 3 section combination ladder. Easy-to-use mechanism to transform the ladder in standing position. Comfortable non-slip rung (30x30 mm) and inner width of the ladder 300 mm. Slip-resistant cross-beam and safety straps.

Échelle professionnelle transformable 3 plans en fibre de verre. Articulation facile à utiliser pour transformer l'échelle en position autostable. Échelons antidérapant confortable de (30x30 mm) et largeur intérieure de l'échelle de 300 mm. Embase stabilisatrice antidérapant et sangles de sécurité.

Escalera profesional industrial de fibra de vidrio de 3 tramos. Dispositivo fácil de utilizar para transformar la escalera en posición de tijera. Cómodo peldaño antideslizante de (30x30 mm) y ancho interior de la escalera de 300 mm. Base estabilizadora antideslizante y cintas de seguridad.

OPÇÃO
OPTION | OPTION | OPCION



EN 131

PRO



EN 131	PRO	2x9	2x10	2x12	2x14	2,60m	2,88m	3,44m	4,00m	4,28m	4,84m	5,96m	7,08m	4,14m	5,87m	6,95m	8,03m	0,41m	0,12m	14,81kg	16,13kg	18,77kg	21,44kg	
5604620152092																								

FIBRA CORDA X2

Escada profissional de 2 lances extensível com corda em fibra de vidro. Mecanismo de corda para facilitar a abertura da escada. Degrau antiderrapante confortável (30x30 mm) e largura interior da escada com 300 mm. Estabilizador de segurança antiderrapante.

Fiberglass professional 2 section extension ladder - rope operated. Rope mechanism to facilitate the opening of the ladder. Comfortable non-slip rung (30x30 mm) and inner width of the ladder 300 mm. Slip-resistant safety cross-beam.

Échelle professionnelle coulissante à corde 2 plans en fibre de verre. Mécanisme à corde pour faciliter l'ouverture de l'échelle. Échelons antidérapant confortable de (30x30 mm) et largeur intérieure de l'échelle de 300 mm. Embase stabilisatrice antidérapant pour plus de sécurité.

Escalera profesional extensible 2 tramos con cuerda de fibra de vidrio. Mecanismo de cuerda para facilitar la apertura de la escalera. Cómodo peldaño antideslizante de (30x30 mm) y ancho interior de la escalera de 300 mm. Base estabilizadora antideslizante de seguridad.

OPÇÃO
OPTION | OPTION | OPCION



EN 131

PRO

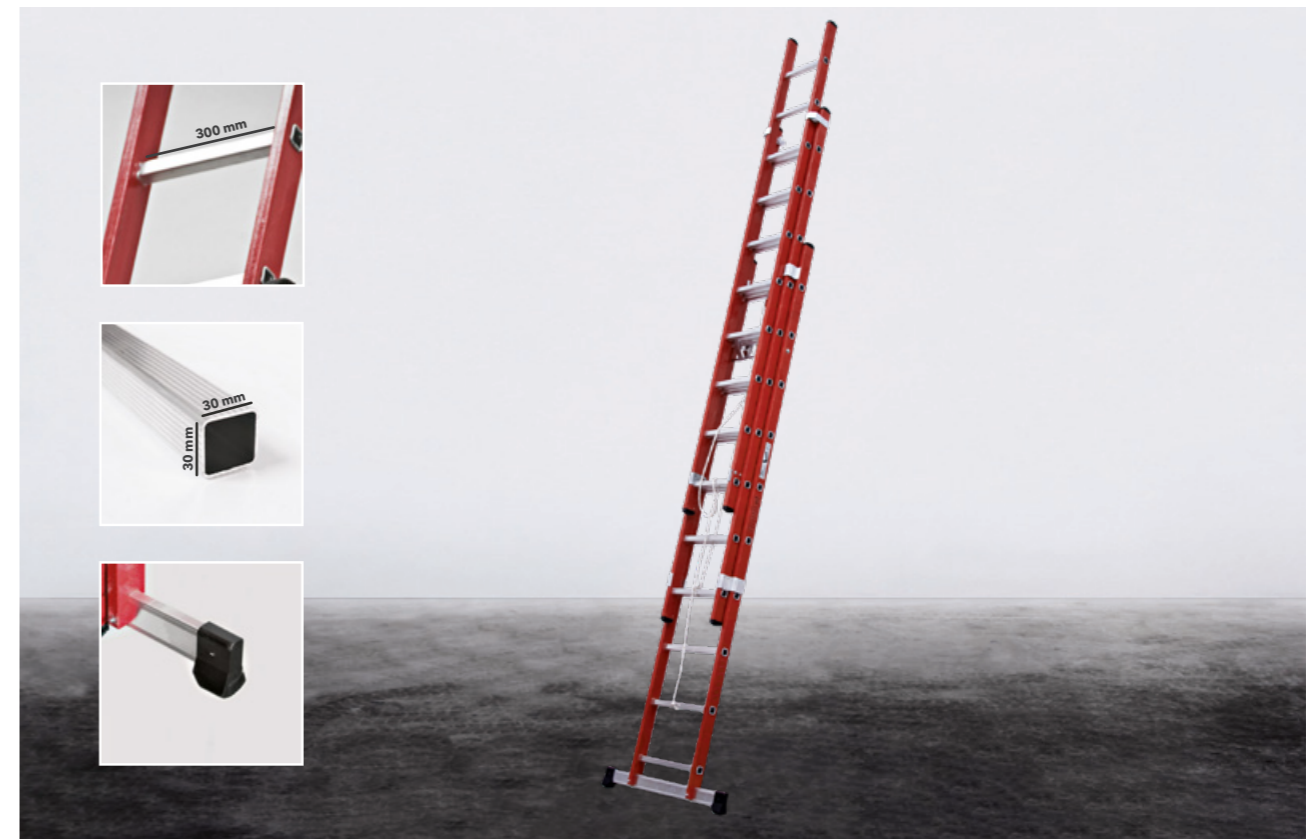

EN 131	PRO	3x9	3x10	2,60m	2,88m	5,40m	6,24m	5,22m	6,03m	6,41m	7,22m	0,48m	0,16m	22,39kg	24,36kg

FIBRA CORDA X3

Escada profissional de 3 lances extensível com corda em fibra de vidro. Mecanismo de corda para facilitar a abertura da escada. Degrau antiderrapante confortável (30x30 mm) e largura interior da escada com 300 mm. Estabilizador de segurança antiderrapante.

Fiberglass professional 3 section extension ladder - rope operated. Rope mechanism to facilitate the opening of the ladder. Comfortable non-slip rung (30x30 mm) and inner width of the ladder 300 mm. Slip-resistant safety cross-beam.

Échelle professionnelle coulissante à corde 3 plans en fibre de verre. Mécanisme à corde pour faciliter l'ouverture de l'échelle. Échelons antidérapant confortable de (30x30 mm) et largeur intérieure de l'échelle de 300 mm. Embase stabilisatrice antidérapant pour plus de sécurité.

Escalera profesional extensible 3 tramos con cuerda de fibra de vidrio. Mecanismo de cuerda para facilitar la apertura de la escalera. Cómodo peldaño antideslizante de (30x30 mm) y ancho interior de la escalera de 300 mm. Base estabilizadora antideslizante de seguridad.

OPÇÃO
OPTION | OPTION | OPCION



EN 131

PRO

Ferral - José Luís & Ca. Lda

Rua dos Sobrais, 655
Zona Industrial Sul - Apartado 70
3885-307 Cortegaça, Portugal

T. +351 256 790 800
E. ferraljl@ferraljl.com

